

Dry-installed Volute Casing Pump

## Sewatec / Sewabloc

50 / 60 Hz  
DIN / IEC Motors

### Type Series Booklet

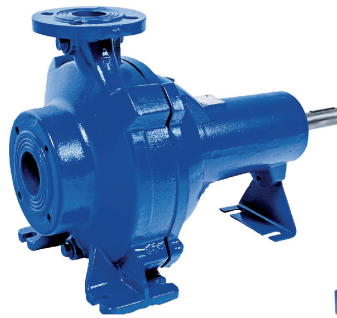

Sewatec

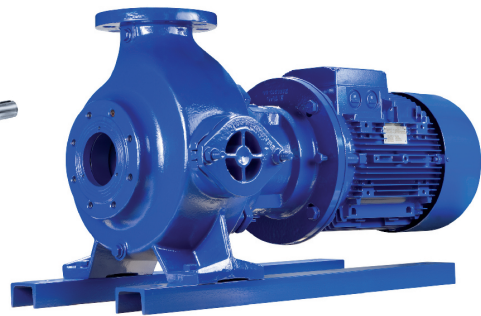

Sewabloc

## **Legal information/Copyright**

Type Series Booklet Sewatec / Sewabloc

All rights reserved. The contents provided herein must neither be distributed, copied, reproduced, edited or processed for any other purpose, nor otherwise transmitted, published or made available to a third party without the manufacturer's express written consent.

Subject to technical modification without prior notice.

© KSB SE & Co. KGaA, Frankenthal 2022-11-02

---

## Contents

<b>Waste Water</b> .....	<b>4</b>
Dry-installed Volute Casing Pumps .....	4
Sewatec / Sewabloc .....	4
Main applications.....	4
Fluids handled .....	4
Operating data.....	4
Design details .....	4
Designation .....	5
Materials.....	6
Product benefits.....	7
Acceptance tests and warranty .....	8
Selection information .....	8
Overview of product features / selection tables .....	9
Technical data .....	24
Selection charts .....	33
Types of installation.....	45
Recommended spare parts stock for 2 years' operation to DIN 24296.....	52
Scope of supply .....	52
General arrangement drawings with list of components .....	53

## Waste Water

### Dry-installed Volute Casing Pumps

## Sewatec / Sewabloc

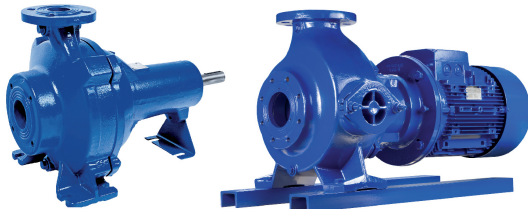

Sewatec

Sewabloc

### Main applications

- Waste water transport
- Waste water disposal
- Waste water management
- Transport of contaminated surface water
- Sludge processing

### Fluids handled

- Grey water
- Solids-laden river water
- Contaminated surface water
- Waste water with faeces
- Industrial waste water
- Gas-containing liquids
- Activated sludge
- Digested sludge
- Raw sludge

### Operating data

Table 1: Operating properties

Characteristic		Impeller type			
		F	E	D	K
Flow rate	Q [m <sup>3</sup> /h]	≤ 680	≤ 2520	≤ 1500	≤ 10000
	Q [l/s]	≤ 189	≤ 700	≤ 450	≤ 2775
Head	H [m]	≤ 80	≤ 50	≤ 80	≤ 115
Fluid temperature	T [°C]	≤ 70 <sup>1)</sup>	≤ 70 <sup>1)</sup>	≤ 70 <sup>1)</sup>	≤ 70 <sup>1)</sup>
Operating pressure	p [bar]	≤ 10	≤ 10	≤ 10	≤ 10

<sup>1</sup> For Sewabloc with explosion protection T [°C] ≤ 40

### Design details

#### Design

Sewatec:

- Volute casing pump
- Back pull-out design
- Single-stage
- Various, application-oriented installation types

Sewabloc:

- Volute casing pump
- Close-coupled pump with shaft seal
- Various, application-oriented installation types

#### Shaft seal

Sewatec (bearing brackets S01, S02, S03, S04), Sewabloc:

- Two bi-directional mechanical seals in tandem arrangement, with liquid reservoir

Sewatec (bearing brackets S05, S06, S07, S08, S09, S10):

- Two bi-directional mechanical seals in tandem arrangement, with liquid reservoir
- Gland packing

#### Impeller type

- Various application-oriented impeller types (⇒ Page 10)

#### Bearings

Sewatec (bearing brackets S01, S02, S03, S04):

- Grease-packed, zero-maintenance deep groove ball bearings (sealed for life) on pump and drive end

Sewatec (bearing brackets S05, S06, S07, S08, S09, S10):

- Grease-packed rolling element bearings with relubrication system on pump and drive end

Sewabloc:

- Grease-packed, zero-maintenance deep groove ball bearing (sealed for life) on pump end

## Designation

**Example: Sewatec K100-253G 3ENH 200L 4**

**Table 2:** Designation key

Code	Description		
Sewatec	Type series		
	Sewatec		
	Sewabloc		
K	Impeller type (⇒ Page 4)		
	F/F-max	Vortex impeller	
	E/E-max	Closed single-channel impeller	
	D/D-max	Open diagonal single-vane impeller / open radial multi-vane impeller	
	K/K-max	Closed multi-channel impeller	
100	Nominal discharge nozzle diameter [mm]		
253	Nominal impeller diameter [mm]		
G	Material variant (⇒ Page 6)		
	G	Standard variant, wetted components made of grey cast iron	
	G1	Like G, impeller made of duplex stainless steel	
	G2	Like G, impeller made of white cast iron	
	GH	Like G, impeller and intermediate casing made of white cast iron	
	GC	Like G, impeller and discharge cover made of duplex stainless steel	
3ENH	Installation type (⇒ Page 45)		
	Sewabloc	BLOC	
		BLOC-V	
		BLOC-VF	
	Sewatec	Fig.0	
		3EN	
		3ENH	
		3HZ	
		3HM	
		3HVGN	
		3HVGNH	
		V	
		VU	
		VGW	
		200L	Motor size
4		Number of motor poles	
	2, 4, 6, 8, 10, 12		

**Materials**
**Table 3: Overview of available materials**

Part No.	Description	Material variant				
		G	G1	G2	GH	GC
101	Pump casing	EN-GJL-250				
135	Wear plate <sup>2)</sup>	EN-GJL-250 <sup>3)4)</sup>		EN-GJN-HB555 (XCR14)	-	
163	Discharge cover	EN-GJL-250 <sup>5)</sup>			EN-GJN-HB555 (XCR14)	1.4517
183	Support foot	Steel				
210	Shaft	1.4021				1.4462
230	Impeller	EN-GJL-250 <sup>4)</sup>	1.4517	EN-GJN-HB555 (XCR14)		1.4517
330	Bearing bracket	EN-GJL-250				
433	Mechanical seal	SiC/SiC (Q1Q1 PGG)				
452.01	Gland follower <sup>6)</sup>	EN-GJS-400-15				
454.01	Stuffing box ring <sup>6)</sup>	EN-GJL-250				
456.01	Neck bush <sup>6)</sup>	EN-GJL-250				
458.01	Lantern ring <sup>6)</sup>	PTFE				
502.01	Casing wear ring <sup>7)</sup>	EN-GJL-250 <sup>8)</sup>	EN-GJL-250 (for impeller F only) VG 434			
503	Impeller wear ring <sup>9)</sup>	VG 434				
524.01	Shaft protecting sleeve <sup>6)</sup>	1.4021				
914	Impeller screw	Stainless steel <sup>10)</sup>		Stainless steel		
902 / 920	Screws, bolts and nuts	Stainless steel <sup>10)</sup>		Stainless steel		
-	Screw plugs	Steel				
-	Sealing elements	NBR				

**Table 4: Comparison of materials**

EN	ASTM
1.4021	A 276 Type 420
1.4462	A 182 F51
1.4517	A 890 CD4MCuN

EN	ASTM
CK 35N	A 29 Gr. 1035
EN-GJL-250	A 48 Class 35 B
EN-GJN-HB555	A 532 Class II Type B (15 % Cr-Mo)
EN-GJS-400-15	A 536 Class 60-40-18
VG 434	-

**Description of materials**
**EN-GJL-250 grey cast iron (lamellar graphite cast iron)**

Lamellar graphite cast iron to EN 1561 is the most widely used cast material for handling municipal sewage, waste water and sludges as well as stormwater and surface water. It is suitable for neutral fluids which are only slightly aggressive and cause little wear. The pH should be  $\geq 6.5$ , the sand content  $\leq 0.5$  g/l.

**Duplex stainless steel (1.4517 or technically equivalent material)**

This type of carbon steel is resistant to cavitation, has excellent strength values and is used for high circumferential speeds. An excellent resistance to pitting corrosion makes ferritic-austenitic stainless carbon steel a popular choice for pumping acidic waste water with a high chloride content as well as seawater and brackish water. Thanks to its good chemical resistance, e.g. against waste water containing phosphorous and sulphuric acid, this material is used in a wide range of applications in the chemical industry and process engineering. Pumps made of duplex stainless steel have a very long service life, even when handling brines, chemical waste water (pH 1 - 12), grey water and landfill leachate.

**Wear-resistant white cast iron (EN-GJN-HB555 [XCR14] or technically equivalent material)**

- 2 Only for impellers D and E200-500, E250-500, E250-630, E300-630, E350-710
- 3 Optional for D impeller: EN-GJN-HB555(XCR14)
- 4 D impeller (multi-vane impeller): EN-GJS-400
- 5 D impeller (multi-vane impeller): EN-GJS-400-15, D impellers have hardened edges.
- 6 For versions with gland packing only
- 7 Not for F impeller with nominal impeller diameters 215, 216, 217
- 8 For E100-250, E100-401, E150-401, E200-401: EN-GJN-HB555(XCR14)
- 9 Optional for K impeller
- 10 Bearing brackets S05 and larger: CK 35N

Wear-resistant white cast iron is suitable for handling highly abrasive fluids containing sand, ash or iron ore sinter, for example. It has a Rockwell hardness of at least 54 HRC, which is higher than that of hardened chrome steel. Owing to its hardness, the chromium-molybdenum alloy cast iron features a notably higher wear resistance than EN-GJL-250 grey cast iron and other cast materials. The pH should be  $\geq 6.5$ .

**Product benefits**

- Variable hydraulic system: the right impeller with optimum efficiency for every fluid. High operating reliability due to large free passages.
- Double mechanical seal in tandem arrangement with fluid reservoir makes for high operating reliability.
- Low maintenance thanks to grease-packed rolling element bearings
- Standardised components are interchangeable within the Sewatec/Sewabloc and Amarex KRT series, so spare parts inventories can be optimised and costs reduced.

## Acceptance tests and warranty

### Functional test

- Each pump is subjected to a performance test to KSB Standard ZN 56535.

#### K/K-max impeller:

- Operating data is guaranteed to DIN EN ISO 9906/2B. It can also be guaranteed to DIN EN ISO 9906/1B, 3B and 1U (with re-evaluation of D2 and  $\eta$ ).

#### F/F-max, E/E-max, D/D-max impellers:

- Operating data is guaranteed to DIN EN ISO 9906/3B. It can also be guaranteed to DIN EN ISO 9906/2B.

#### Power input P<sub>2</sub> of the pump below 10 kW.

- Operating data is guaranteed to DIN EN ISO 9906 §4.4.2. Other acceptance grades are not approved.

### Acceptance inspections/tests

- Acceptance test to ISO/DIN or comparable standards available against a surcharge.

### Warranty

- Quality is assured by means of an audited and certified quality assurance system to DIN EN ISO 9001.

### Selection information

- The indicated heads and performance data apply to material variant G, for fluids with a density  $\rho = 1 \text{ kg/dm}^3$  and a kinematic viscosity  $\nu \leq 20 \text{ mm}^2/\text{s}$ .

### Impeller type

- F, E, and D impellers can only be supplied with the documented impeller diameters. Indicate the pump set designation and the impeller diameter in the purchase order.
- Impellers K and D-max are trimmed to the duty point. Indicate the H/Q data or the impeller diameter in the purchase order. In the hydraulic selection program, the impeller diameter is automatically computed based on the H/Q data and added to the designation of the pump set.

### Pump input power

- Adjust the power input to the density of the fluid handled:  
 $P_2 \text{ (Power input)} = \rho \text{ [kg/dm}^3\text{]} \text{ (fluid handled)} \times P_2 \text{ (documented)}$
- Select the operating point with the largest power input within an operating range. Select a motor size providing a power reserve to compensate the tolerances in the system characteristic / pump characteristic.

**Table 5:** Recommended motor power reserve<sup>11)</sup>

P <sub>2</sub>		Reserve	
[hp]	[kW]	Mains operation	With frequency inverter
≤ 40	≤ 30	10 %	15 %
> 40	> 30	5 %	10 %

In the case of waste water, too low a flow velocity in the discharge line will lead to clogging and increased wear. The minimum flow velocity required in vertical risers was determined experimentally as a function of the pipe diameter used and shown to be between 3.9 ft/s [1.2 m/s] for nominal size 100 and 7.9 ft/s [2.4 m/s] for nominal size 1000. For more information on flow velocities required in horizontal and vertical discharge lines refer to "KSB Know-how: Planning Information for Amarex KRT Submersible Motor Pumps".

In the case of waste water, too low a circumferential speed of the impeller will lead to clogging of the hydraulic system (operation on a frequency inverter). A minimum circumferential speed (measured at the outside diameter of the impeller) of 39.4 ft/s [12 m/s] must be observed.<sup>12)</sup>

<sup>11)</sup> If larger power reserves are stipulated by local regulations, these larger reserves must be provided.

<sup>12)</sup> For F impellers, a circumferential speed below 39.4 ft/s [12 m/s] is permissible.



## Overview of product features / selection tables

### Overview of product features

Table 6: Symbols key

Symbol	Description
●	Standard design
■	Standard variant <sup>13)</sup>
○	Special design <sup>13)</sup>

Table 7: Overview of features and accessories per installation type

Options	Sewatec					Sewabloc		
	Fig. 0	V	3E	3H	3H with counter shaft	BLOC	BLOC-V	BLOC-VF
<b>Motor:</b>								
▪ Without motor	●	●	●	●	●	●	●	●
▪ Standard KSB motor	-	■ <sup>14)</sup>	●	●	●	●	●	●
▪ Motor make to customer's choice	-	■ <sup>14)</sup>	■	■	■	■	■	■
<b>Accessories installation set:</b>								
▪ Baseplate	-	● <sup>15)</sup>	● <sup>16)</sup>	● <sup>17)</sup>	● <sup>18)</sup>	● <sup>15)</sup>	● <sup>19)</sup>	-
▪ Support frame, drive lantern, soleplate for the motor <sup>20)</sup>	-	○	-	-	-	-	-	-
▪ Coupling, coupling guard <sup>20)</sup>	-	● <sup>21)</sup>	●	-	●	-	-	-
▪ Suction-side flanged spacer with inspection hole <sup>20)</sup>	●	● <sup>22)</sup>	●	●	●	●	● <sup>22)</sup>	-
▪ Suction duckfoot bend	-	○	-	-	-	-	-	●
▪ Fasteners: anchor bolts (A4)	-	● <sup>23)</sup>	●	●	●	●	●	●
<b>Shaft seal:</b>								
▪ Mechanical seal	Standard KSB mechanical seal with elastomer bellows (bearing brackets S01, S02, S03, S04, S05, S06, S07, B01, B02, B03)				●			
	Standard KSB mechanical seal with covered spring (bearing brackets S01, S02, S03, S04, S05)				■			
	Cartridge seal KSB 45TQ				■			
	Stationary mechanical seal with spring outside of fluid (bearing brackets S08, S09, S10)				●			
▪ Gland packing (bearing brackets S05 and larger only)			■		-			-
<b>Coating:</b>								
▪ KSB standard					●			
▪ Primed to standard					●			
▪ Customer specification					○			
<b>Flange:</b>								
▪ To DIN					●			

13 The selection of standard variants or special designs will determine whether surcharges or longer delivery times apply.

14 Special design for universal-joint shaft

15 Foundation rail

16 With height adjustment of the motor

17 Including belt drive, belt guard and height adjustment of the motor (for motors 225S and larger)

18 Including belt drive, belt guard, counter shaft, coupling and coupling guard

19 Soleplate

20 Optional





21 For underfloor installation

22 Suction elbow

23 For foundation rails: machine bolts

Options	Sewatec					Sewabloc		
	Fig. 0	V	3E	3H	3H with counter shaft	BLOC	BLOC-V	BLOC-VF
<ul style="list-style-type: none"> <li>To ANSI</li> </ul>					○			
Sealing elements, bolts and screws								
NBR/A4 <sup>24)</sup>					●			
<ul style="list-style-type: none"> <li>O-rings (Viton) and screws/bolts (A4)</li> </ul>					■			
<ul style="list-style-type: none"> <li>Shaft made of 1.4462</li> </ul>					■			
Acceptance inspections/tests								
<ul style="list-style-type: none"> <li>KSB standard ZN 56535</li> </ul>					●			
<ul style="list-style-type: none"> <li>Customer specification</li> </ul>					■			
Sensors:								
<ul style="list-style-type: none"> <li>Leakage monitoring at the shaft seal</li> </ul>					■			
<ul style="list-style-type: none"> <li>Pt100 resistance thermometer at the bearing</li> </ul>					■			
<ul style="list-style-type: none"> <li>Vibration sensor at the bearing bracket</li> </ul>					■			

### Impellers

	Vortex impeller (impeller type F/F-max)	<b>Suitable for the following fluids:</b> fluids containing solids and stringy material as well as fluids with entrapped air or entrapped gas
	Closed single-channel impeller (impeller type E/E-max)	<b>Suitable for the following fluids:</b> fluids containing solids and stringy material
	Open, diagonal single-vane impeller (impeller type D)	<b>Suitable for the following fluids:</b> fluids containing solid substances and long fibres
	Open radial multi-vane impeller (impeller type D-max)	<b>Suitable for the following fluids:</b> fluids containing solid substances and long fibres

Further fluids (impeller types F/F-max, E/E-max, D/D-max):

- Activated sludge
- Digested sludge
- Heating sludge
- Mixed water
- Raw waste water
- Raw sludge
- Recirculated sludge

	Closed multi-channel impeller (impeller type K/K-max)	<b>Suitable for the following fluids:</b> contaminated, solids-laden, non-gaseous fluids without stringy material
---	---	--

Further fluids (impeller type K/K-max):

<sup>24)</sup> Screw plugs made of steel

- Activated sludge
- Landfill waste water
- Industrial waste water
- Industrial grey water
- Mechanically treated waste water
- Pre-screened waste water
- Stormwater

## Overview of fluids handled

The table below for your guidance is based on KSB's long-standing experience. The data are standard values and are not to be considered as generally binding recommendations. More detailed advice is available from KSB. Make use of our laboratory's expertise when selecting materials.

**Table 8:** Selection aid for materials and hydraulic systems per fluid

Fluid handled <sup>25)</sup>	Recommended material variant	Recommended impeller type <sup>26)</sup>	Notes, further recommendations
Grey water	G	K/K-max, D/D-max, E/E-max, F/F-max	Free passage > any solids contained, possibly pre-screened
River water	G	K/K-max, D/D-max, E/E-max, F/F-max	Free passage > any solids contained, possibly pre-screened
Stormwater	G	K/K-max, D/D-max, E/E-max, F/F-max	Free passage > any solids contained, possibly pre-screened
<b>Waste water:</b>			
▪ Untreated municipal waste water	G	F/F-max, D/D-max, E/E-max, K/K-max	ATV <sup>27)</sup> -recommends a free passage of 100 mm; minimum free passage: 76 mm
▪ Containing air and gas	G	F/F-max	Up to 8 %, contact KSB for handling fluids with high outgassing rates
<b>Sludges:</b>			
▪ Raw sludge	G	F/F-max, D/D-max, E/E-max	Pumpable up to a dry substance content of: 13 % (D), 8 % (F/D-max), 6 % (E)
▪ Digested sludge	G	F/F-max, D/D-max, E/E-max	Pumpable up to a dry substance content of: 13 % (D), 8 % (F/D-max), 6 % (E)
▪ Activated sludge	G	D/D-max, K/K-max	Pumpable up to a dry substance content of: 13 % (D), 8 % (D-max), 5 % (K)
<b>Industrial waste water containing:</b>			
▪ Paint suspensions	G	K/K-max	Solvent-free, observe the operator's instructions.
▪ Lacquer/paint/varnish suspensions	G	F/F-max, E/E-max	Solvent-free, contact KSB for silicone-free version
▪ Fibrous material	G	F/F-max, D/D-max	-
▪ Chips/swarf	G2/GH	K/K-max, F/F-max	G2 or GH variant, special mechanical seal KSB 4STQ; solids content
▪ Abrasive substances <sup>28)</sup>	G2/GH	K/K-max, F/F-max	G2 or GH variant, special mechanical seal KSB 4STQ; solids content
▪ Mildly acidic industrial waste water	GC/C	K/K-max, F/F-max	pH ≥ 6.5 material variant C (selected sizes only) and FPM (Viton) O-rings
<b>Non-corrosive waste water containing:</b>			
▪ Ammonium hydroxide	G	K/K-max	-
▪ Ammonium hydroxide 5 % NH <sub>4</sub> OH	G	K/K-max	-

<sup>25)</sup> For any fluids which are not listed in this table contact KSB.

<sup>26)</sup> The first impeller type listed should be given preference.

<sup>27)</sup> ATV = German regulatory body for waste water management

<sup>28)</sup> Severe hydroabrasive wear occurs if solids contents of approx. 0.5 g/l or higher are combined with circumferential speeds exceeding 20 m/s or low-flow conditions to the left of the duty point.

Fluid handled <sup>25)</sup>	Recommended material variant	Recommended impeller type <sup>26)</sup>	Notes, further recommendations
▪ Urea 25 % (NH <sub>2</sub> ) <sub>2</sub> -CO	G	K/K-max	-
▪ Potassium hydroxide 10 % KOH	G	K/K-max	-
▪ Calcium hydroxide 5 % Ca(OH) <sub>2</sub>	G	K/K-max	-
▪ Sodium hydroxide 5 % NaOH	G	K/K-max	-
▪ Sodium carbonate 30 % Na <sub>2</sub> CO <sub>3</sub>	G	K/K-max	-
Non-corrosive waste water containing:			
▪ Aliphatic hydrocarbons, e.g. oils, petrol, butane, methane	G	K/K-max	-
▪ Aromatic hydrocarbons, e.g. benzene, styrene	G	K/K-max	FPM (Viton) O-rings <sup>29)</sup>
▪ Chlorinated hydrocarbons (e.g. tetrachloroethylene, ethylene chloride, chloroform, methylene chloride)	G	K/K-max	FPM (Viton) O-rings <sup>29)</sup>
Highly abrasive industrial waste water causing wear (chemically neutral) : <sup>30)</sup>			
▪ Water containing iron ore sinter	GH	K/K-max	Sinter content < 5 g/l: material variant GH Sinter content > 5 g/l: material variant H (on request)
▪ Lime milk containing quartz and pigment suspensions	GH	K/K-max	Lime milk contents < 15 %: material variant GH Lime milk content > 15 %: material variant H (on request)
▪ Wash water containing solids	-	K/K-max, F/F-max	Material selection based on fluid analysis
▪ Waste water containing dust or ash	-	K/K-max	Material selection based on fluid analysis
Water/sand mixture	GH	K/K-max, F/F-max	Solids contents < 5 g/l: material variant GH Solids content > 5 g/l: material variant H (on request)
Seawater	C	K/K-max, F/F-max	Material variant C (for selected sizes) ≤ 25 °C fluid temperature <sup>31)</sup>
Brackish water	C	K/K-max, F/F-max	Material variant C (for selected sizes) or GC (with 250 µm two-component epoxy resin), depending on salt content
Corrosive industrial waste water	C	K/K-max, F/F-max	Material variant available for selected sizes and depending on the fluid analysis

<sup>29)</sup> The hydrocarbons mentioned may occur in very high concentrations due to the difference in specific weight and their low solubility. If this is the case, contact KSB. .

<sup>30)</sup> The required material variants highly depend on the operating hours, rotational speed and flow velocity.

<sup>31)</sup> Higher fluid temperatures on request.

Impeller types per material variant, DIN/IEC motors

Table 9: Impeller types per material variant depending on the pump size, DIN/IEC motors

Size	Bearing bracket		Impeller type														
			F					E	D				K				
	Sewatec	Sewabloc	Material variant														
			G	G1	GC	G2	GH	G	G	G1	G2	G	G1	GC	G2	GH	
050-215	S01	-	X	X	X	X	X	-	-	-	-	-	-	-	-	-	-
050-215	-	B01	X	X	X	X	X	-	-	-	-	-	-	-	-	-	-
050-216	S01	-	X	X	X	X	X	-	-	-	-	-	-	-	-	-	-
050-216	-	B01	X	X	X	X	X	-	-	-	-	-	-	-	-	-	-
050-250	S01	-	-	-	-	-	-	-	-	-	-	X	X	X	X	X	X
050-250	-	B01	-	-	-	-	-	-	-	-	-	X	X	X	X	X	X
050-251	S02	-	-	-	-	-	-	-	-	-	-	X	X	X	X	X	X
050-251	-	B02	-	-	-	-	-	-	-	-	-	X	X	X	X	X	X
065-215	S01	-	X	X	X	X	X	-	-	-	-	-	-	-	-	-	-
065-215	-	B01	X	X	X	X	X	-	-	-	-	-	-	-	-	-	-
065-216	S02	-	-	-	-	-	-	X	-	-	-	-	-	-	-	-	-
065-216	-	B02	-	-	-	-	-	X	-	-	-	-	-	-	-	-	-
065-217	S01	-	X	X	X	X	X	-	-	-	-	-	-	-	-	-	-
065-217	-	B01	X	X	X	X	X	-	-	-	-	-	-	-	-	-	-
065-250	S01	-	-	-	-	-	-	-	-	-	-	X	-	-	-	-	-
065-250	-	B01	-	-	-	-	-	-	-	-	-	X	-	-	-	-	-
080-215	S01	-	X	X	X	X	X	-	-	-	-	-	-	-	-	-	-
080-215	-	B01	X	X	X	X	X	-	-	-	-	-	-	-	-	-	-
080-216	S01	-	X	X	X	X	X	-	-	-	-	-	-	-	-	-	-
080-216	-	B01	X	X	X	X	X	-	-	-	-	-	-	-	-	-	-
080-216	S02	-	-	-	-	-	-	X	-	-	-	-	-	-	-	-	-
080-216	-	B02	-	-	-	-	-	X	-	-	-	-	-	-	-	-	-
080-217	S01	-	X	X	X	X	X	-	-	-	-	-	-	-	-	-	-
080-217	-	B01	X	X	X	X	X	-	-	-	-	-	-	-	-	-	-
080-250	S01	-	-	-	-	-	-	-	-	-	-	X	X	X	X	X	X
080-250	-	B01	-	-	-	-	-	-	-	-	-	X	X	X	X	X	X
080-252	S01	-	X	X	X	X	X	-	-	-	-	-	-	-	-	-	-
080-252	-	B01	X	X	X	X	X	-	-	-	-	-	-	-	-	-	-
080-253	S02	-	X	X	X	X	X	X	-	-	-	-	-	-	-	-	-
080-253	-	B02	X	X	X	X	X	X	-	-	-	-	-	-	-	-	-
080-315	S03	-	-	-	-	-	-	-	X	X	-	X	X	X	X	X	X
080-315	-	B03	-	-	-	-	-	-	X	X	-	X	X	X	X	X	X
080-315	S05	-	-	-	-	-	-	-	X	X	-	-	-	-	-	-	-
080-316	S03	-	-	-	-	-	-	-	X	X	-	-	-	-	-	-	-
080-316	-	B03	-	-	-	-	-	-	X	X	-	-	-	-	-	-	-
080-317	S03	-	X	X	X	X	X	-	X	X	-	-	-	-	-	-	-
080-317	-	B03	X	X	X	X	X	-	X	X	-	-	-	-	-	-	-
100-215	S01	-	X	X	-	X	X	-	-	-	-	-	-	-	-	-	-
100-215	-	B01	X	X	-	X	X	-	-	-	-	-	-	-	-	-	-
100-250	S01	-	-	-	-	-	-	X	-	-	-	-	-	-	-	-	-
100-250	-	B01	-	-	-	-	-	-	-	-	-	-	-	-	-	-	-
100-251	S02	-	X	X	X	X	X	-	-	-	-	-	-	-	-	-	-
100-251	-	B02	X	X	X	X	X	-	-	-	-	-	-	-	-	-	-
100-252	S01	-	X	-	-	-	-	-	-	-	-	-	-	-	-	-	-
100-252	-	B01	X	-	-	-	-	-	-	-	-	-	-	-	-	-	-
100-253	S02	-	X	-	-	-	-	X	X	X	-	X	X	X	X	X	X
100-253	-	B02	X	-	-	-	-	-	X	X	-	X	X	X	X	X	X
100-254	S01	-	X	X	X	X	X	-	-	-	-	X	X	X	X	X	X
100-254	-	B01	X	X	X	X	X	-	-	-	-	X	X	X	X	X	X
100-315	S05	-	-	-	-	-	-	-	X	X	-	-	-	-	-	-	-
100-316	S03	-	X	X	X	X	X	-	X	X	-	X	X	X	X	X	X
100-316	-	B03	X	X	X	X	X	-	X	X	-	X	X	X	X	X	X
100-317	S03	-	-	-	-	-	-	X	-	-	-	-	-	-	-	-	-

Size	Bearing bracket		Impeller type														
			F					E	D				K				
	Sewatec	Sewabloc	Material variant														
			G	G1	GC	G2	GH	G	G	G1	G2	G	G1	GC	G2	GH	
100-400	S04	-	-	-	-	-	-	-	-	-	-	-	X	X	-	-	-
100-400	S05	-	-	-	-	-	-	-	-	-	-	-	X	X	-	-	-
100-401	S04	-	X	X	-	X	-	X	-	-	-	-	X	X	-	X	-
100-401	S05	-	X	X	-	X	-	X	-	-	-	-	X	X	-	X	-
100-403	S04	-	-	-	-	-	-	-	-	X	X	X	-	-	-	-	-
100-403	S05	-	-	-	-	-	-	-	-	X	X	X	-	-	-	-	-
150-253	S02	-	-	-	-	-	-	-	-	X	X	-	-	-	-	-	-
150-253	-	B02	-	-	-	-	-	-	-	X	X	-	-	-	-	-	-
150-315	S03	-	X	X	X	X	X	-	X	X	-	-	-	-	-	-	-
150-315	-	B03	X	X	X	X	X	-	X	X	-	-	-	-	-	-	-
150-317	S03	-	-	-	-	-	-	X	X <sup>32)</sup>	X <sup>32)</sup>	X <sup>32)</sup>	X	X	X	X	X	X
150-317	-	B03	-	-	-	-	-	-	X <sup>32)</sup>	X <sup>32)</sup>	X <sup>32)</sup>	X	X	X	X	X	X
150-317	S05	-	-	-	-	-	-	-	-	-	-	X	X	X	X	X	X
150-400	S04	-	-	-	-	-	-	-	-	-	-	-	X	X	-	X	-
150-400	S05	-	-	-	-	-	-	-	-	X	X	-	X	X	-	X	-
150-401	S04	-	X	X	-	X	-	X	-	-	-	-	-	-	-	-	-
150-401	S05	-	X	X	-	X	-	X	X	X	-	-	-	-	-	-	-
150-401	S06	-	-	-	-	-	-	X	X	X	-	-	-	-	-	-	-
150-403	S04	-	-	-	-	-	-	-	X	X	X	X	X	-	X	-	-
150-403	S05	-	-	-	-	-	-	-	X	X	X	X	X	-	X	-	-
150-503	S06	-	-	-	-	-	-	-	X <sup>32)</sup>	X <sup>32)</sup>	X <sup>32)</sup>	X	X	-	-	-	-
150-503	S07	-	-	-	-	-	-	-	X <sup>32)</sup>	X <sup>32)</sup>	X <sup>32)</sup>	X	X	-	-	-	-
151-403	S04	-	-	-	-	-	-	-	-	-	-	-	X	X	-	X	-
151-403	S05	-	-	-	-	-	-	-	-	-	-	-	X	X	-	X	-
200-315	S03	-	-	-	-	-	-	-	X	X	-	X	X	X	X	X	X
200-315	-	B03	-	-	-	-	-	-	X	X	-	X	X	X	X	X	X
200-316	S03	-	-	-	-	-	-	-	-	-	-	-	X	X	X	X	X
200-316	-	B03	-	-	-	-	-	-	-	-	-	-	X	X	X	X	X
200-317	S03	-	-	-	-	-	-	-	-	-	-	-	X	X	X	X	X
200-317	-	B03	-	-	-	-	-	-	-	-	-	-	X	X	X	X	X
200-317	S05	-	-	-	-	-	-	-	-	-	-	-	X	X	X	X	X
200-318	S03	-	-	-	-	-	-	-	-	-	-	-	X	X	X	X	X
200-318	-	B03	-	-	-	-	-	-	-	-	-	-	X	X	X	X	X
200-400	S05	-	-	-	-	-	-	-	-	X	X	-	-	-	-	-	-
200-400	S06	-	-	-	-	-	-	-	-	X	X	-	-	-	-	-	-
200-401	S04	-	-	-	-	-	-	X	-	-	-	-	-	-	-	-	-
200-401	S05	-	-	-	-	-	-	X	-	-	-	-	-	-	-	-	-
200-401	S06	-	-	-	-	-	-	X	-	-	-	-	-	-	-	-	-
200-402	S04	-	-	-	-	-	-	-	X	X	X	X	X	-	X	-	-
200-402	S05	-	-	-	-	-	-	-	X	X	X	X	X	-	X	-	-
200-402	S06	-	-	-	-	-	-	-	X	X	X	X	X	-	X	-	-
200-403	S04	-	-	-	-	-	-	-	-	-	-	-	X	X	-	X	-
200-403	S05	-	-	-	-	-	-	-	-	-	-	-	X	X	-	X	-
200-405	S04	-	-	-	-	-	-	-	X	X	X	-	-	-	-	-	-
200-405	S05	-	-	-	-	-	-	-	X	X	X	-	-	-	-	-	-
200-405	S06	-	-	-	-	-	-	-	X	X	X	-	-	-	-	-	-
200-500	S05	-	-	-	-	-	-	X	-	-	-	-	-	-	-	-	-
200-502	S06	-	-	-	-	-	-	-	-	-	-	-	X	X	-	-	-
200-502	S07	-	-	-	-	-	-	-	-	-	-	-	X	X	-	-	-
200-503	S06	-	-	-	-	-	-	-	X <sup>32)</sup>	X <sup>32)</sup>	X <sup>32)</sup>	X	X	-	-	-	-
200-503	S07	-	-	-	-	-	-	-	X <sup>32)</sup>	X <sup>32)</sup>	X <sup>32)</sup>	X	X	-	-	-	-
250-400	S04	-	-	-	-	-	-	-	-	-	-	-	X	X	-	X	-
250-400	S05	-	-	-	-	-	-	-	-	X	X	-	-	-	-	-	-
250-400	S06	-	-	-	-	-	-	-	-	X	X	-	-	-	-	-	-

<sup>32)</sup> Consult the manufacturer.

Size	Bearing bracket		Impeller type														
			F					E	D				K				
	Sewatec	Sewabloc	Material variant														
			G	G1	GC	G2	GH	G	G	G1	G2	G	G1	GC	G2	GH	
250-401	S04	-	-	-	-	-	-	-	-	-	-	-	X	X	-	X	-
250-401	S05	-	-	-	-	-	-	-	-	-	-	-	X	X	-	X	-
250-401	S06	-	-	-	-	-	-	-	-	-	-	-	X	X	-	X	-
250-402	S04	-	-	-	-	-	-	-	X	X	X	-	-	-	-	-	-
250-402	S05	-	-	-	-	-	-	-	X	X	X	-	-	-	-	-	-
250-402	S06	-	-	-	-	-	-	-	X	X	X	-	-	-	-	-	-
250-403	S04	-	-	-	-	-	-	-	-	-	-	X	X	-	X	-	-
250-403	S05	-	-	-	-	-	-	-	-	-	-	X	X	-	X	-	-
250-403	S06	-	-	-	-	-	-	-	-	-	-	X	X	-	X	-	-
250-500	S06	-	-	-	-	-	-	X	-	-	-	-	-	-	-	-	-
250-500	S07	-	-	-	-	-	-	X	-	-	-	-	-	-	-	-	-
250-630	S07	-	-	-	-	-	-	X	-	-	-	-	-	-	-	-	-
250-630	S08	-	-	-	-	-	-	X	-	-	-	-	-	-	-	-	-
250-632	S07	-	-	-	-	-	-	-	-	-	-	X	X	-	-	-	-
250-632	S08	-	-	-	-	-	-	-	-	-	-	X	X	-	-	-	-
250-900	S09	-	-	-	-	-	-	-	-	-	-	X	X	-	-	-	-
300-400	S04	-	-	-	-	-	-	-	-	-	-	X	X	-	X	-	-
300-400	S05	-	-	-	-	-	-	-	X	X	-	X	X	-	X	-	-
300-400	S06	-	-	-	-	-	-	-	X	X	-	-	-	-	-	-	-
300-401	S04	-	-	-	-	-	-	-	-	-	-	X	X	-	X	-	-
300-401	S05	-	-	-	-	-	-	-	-	-	-	X	X	-	X	-	-
300-402	S04	-	-	-	-	-	-	-	X	X	X	-	-	-	-	-	-
300-402	S05	-	-	-	-	-	-	-	X	X	X	-	-	-	-	-	-
300-402	S06	-	-	-	-	-	-	-	X	X	X	-	-	-	-	-	-
300-403	S05	-	-	-	-	-	-	-	-	-	-	X	X	-	X	-	-
300-500	S06	-	-	-	-	-	-	-	-	-	-	X	X	-	-	-	-
300-500	S07	-	-	-	-	-	-	-	-	-	-	X	X	-	-	-	-
300-502	S06	-	-	-	-	-	-	-	X <sup>32)</sup>	X <sup>32)</sup>	X <sup>32)</sup>	-	-	-	-	-	-
300-502	S07	-	-	-	-	-	-	-	X <sup>32)</sup>	X <sup>32)</sup>	X <sup>32)</sup>	-	-	-	-	-	-
300-505	S06	-	-	-	-	-	-	-	X <sup>32)</sup>	X <sup>32)</sup>	X <sup>32)</sup>	X	X	-	-	-	-
300-505	S07	-	-	-	-	-	-	-	X <sup>32)</sup>	X <sup>32)</sup>	X <sup>32)</sup>	X	X	-	-	-	-
300-630	S07	-	-	-	-	-	-	X	-	-	-	-	-	-	-	-	-
300-630	S08	-	-	-	-	-	-	X	-	-	-	-	-	-	-	-	-
350-500	S06	-	-	-	-	-	-	-	-	-	-	X	X	-	-	-	-
350-500	S07	-	-	-	-	-	-	-	-	-	-	X	X	-	-	-	-
350-502	S06	-	-	-	-	-	-	-	X <sup>32)</sup>	X <sup>32)</sup>	X <sup>32)</sup>	-	-	-	-	-	-
350-502	S07	-	-	-	-	-	-	-	X <sup>32)</sup>	X <sup>32)</sup>	X <sup>32)</sup>	-	-	-	-	-	-
350-503	S06	-	-	-	-	-	-	-	X <sup>32)</sup>	X <sup>32)</sup>	X <sup>32)</sup>	X	X	-	-	-	-
350-503	S07	-	-	-	-	-	-	-	X <sup>32)</sup>	X <sup>32)</sup>	X <sup>32)</sup>	X	X	-	-	-	-
350-632	S07	-	-	-	-	-	-	-	-	-	-	X	X	-	-	-	-
350-632	S08	-	-	-	-	-	-	-	-	-	-	X	X	-	-	-	-
350-633	S07	-	-	-	-	-	-	-	-	-	-	X	X	-	-	-	-
350-633	S08	-	-	-	-	-	-	-	-	-	-	X	X	-	-	-	-
350-710	S07	-	-	-	-	-	-	X	-	-	-	-	-	-	-	-	-
350-710	S08	-	-	-	-	-	-	X	-	-	-	X	X	-	-	-	-
350-713	S08	-	-	-	-	-	-	-	-	-	-	X	X	-	-	-	-
350-713	S09	-	-	-	-	-	-	-	-	-	-	X	X	-	-	-	-
400-500	S06	-	-	-	-	-	-	-	-	-	-	X	X	-	-	-	-
400-500	S07	-	-	-	-	-	-	-	-	-	-	X	X	-	-	-	-
400-632	S08	-	-	-	-	-	-	-	-	-	-	X	X	-	-	-	-
400-710	S09	-	-	-	-	-	-	-	-	-	-	X	-	-	-	-	-
400-713	S09	-	-	-	-	-	-	-	-	-	-	X	X	-	-	-	-
400-900	S09	-	-	-	-	-	-	-	-	-	-	X	X	-	-	-	-
500-634	S07	-	-	-	-	-	-	-	-	-	-	X	X	-	-	-	-
500-634	S08	-	-	-	-	-	-	-	-	-	-	X	X	-	-	-	-
500-710	S09	-	-	-	-	-	-	-	-	-	-	X	X	-	-	-	-



Size	Bearing bracket		Impeller type															
			F					E	D				K					
	Sewatec		Sewabloc		Material variant													
					G	G1	GC	G2	GH	G	G	G1	G2	G	G1	GC	G2	GH
500-900	S09	-	-	-	-	-	-	-	-	-	-	-	X	-	-	-	-	
500-900	S10	-	-	-	-	-	-	-	-	-	-	-	X	-	-	-	-	
600-520	S07	-	-	-	-	-	-	-	-	-	-	-	X	-	-	-	-	
600-710	S08	-	-	-	-	-	-	-	-	-	-	-	X	X	-	-	-	
600-900	S10	-	-	-	-	-	-	-	-	-	-	-	X	X	-	-	-	
700-902	S08	-	-	-	-	-	-	-	-	-	-	-	X	X	-	-	-	
700-902	S09	-	-	-	-	-	-	-	-	-	-	-	X	X	-	-	-	

Nominal impeller diameters per bearing bracket and speed - for impeller type F

Table 10: Selection table<sup>33)</sup>

Size	Bearing bracket		50 Hz				60 Hz			
	Sewatec	Sewabloc	2900	1450	960	725	3500	1750	1160	875
050-215	S01	-	210	210	-	-	160	210	-	-
050-215	-	B01	210	210	-	-	160	210	-	-
050-216	S01	-	210	210	-	-	-	210	-	-
050-216	-	B01	210	210	-	-	-	210	-	-
065-215	S01	-	210	210	-	-	-	210	-	-
065-215	-	B01	210	210	-	-	-	210	-	-
065-217	S01	-	200	200	-	-	200	200	-	-
065-217	-	B01	200	200	-	-	200	200	-	-
080-215	S01	-	200	200	-	-	-	-	-	-
080-215	-	B01	200	200	-	-	-	-	-	-
080-216	S01	-	210	210	-	-	-	210	-	-
080-216	-	B01	210	210	-	-	-	210	-	-
080-217	S01	-	-	-	-	-	200	200	-	-
080-217	-	B01	-	-	-	-	200	200	-	-
080-252	S01	-	-	250	-	-	-	-	250	-
080-252	-	B01	-	250	-	-	-	-	250	-
080-253	S02	-	210	265	-	-	-	265	-	-
080-253	-	B02	210	265	-	-	-	265	-	-
080-317	S03	-	240	240	-	-	-	240	240	-
080-317	-	B03	240	240	-	-	-	240	240	-
100-215	S01	-	-	210	-	-	-	210	-	-
100-215	-	B01	-	210	-	-	-	210	-	-
100-251	S02	-	-	265	-	-	-	265	-	-
100-251	-	B02	-	265	-	-	-	265	-	-
100-252	S01	-	-	250	250	-	-	-	250	-
100-252	-	B01	-	250	250	-	-	-	250	-
100-253	S02	-	-	265	-	-	-	265	-	-
100-253	-	B02	-	265	-	-	-	265	-	-
100-254	S01	-	-	249	265	-	-	-	265	-
100-254	-	B01	-	249	265	-	-	-	265	-
100-316	S03	-	-	310	-	-	-	310	-	-
100-316	-	B03	-	310	-	-	-	310	-	-
100-401	S04	-	-	390	390	-	-	-	390	390
100-401	S05	-	-	390	390	-	-	-	390	390
150-315	S03	-	-	-	290	-	-	-	290	290
150-315	-	B03	-	-	290	-	-	-	290	290
150-401	S04	-	-	390	390	-	-	-	390	390
150-401	S05	-	-	390	390	-	-	-	390	390

2580.5/28-EN

<sup>33</sup> Selection for a fluid density of 1.0 kg/dm<sup>3</sup> -1.2 kg/dm<sup>3</sup>; higher densities on request only

**Nominal impeller diameters per bearing bracket and speed - for impeller type E**

Table 11: Selection table<sup>34)35)</sup>

Size	Bearing bracket		50 Hz						60 Hz					
	Sewatec	Sewabloc	2900	1450	960	725	580	480	3500	1750	1160	875	700	585
065-216	S02	-	183	183	-	-	-	-	183	183	-	-	-	-
065-216	-	B02	183	183	-	-	-	-	-	183	-	-	-	-
080-216	S02	-	210	210	-	-	-	-	180	210	-	-	-	-
080-216	-	B02	210	210	-	-	-	-	-	210	-	-	-	-
080-253	S02	-	-	270	-	-	-	-	-	270	270	-	-	-
080-253	-	B02	-	270	-	-	-	-	-	270	270	-	-	-
100-250	S01	-	-	-	245	-	-	-	-	-	245	245	245	-
100-253	S02	-	-	270	-	-	-	-	-	270	270	-	-	-
100-253	-	B02	-	270	-	-	-	-	-	270	270	-	-	-
100-317	S03	-	-	328	-	-	-	-	-	328	328	-	-	-
100-401	S04	-	-	412	412	412	-	-	-	-	-	-	-	-
100-401	S05	-	-	412	412	412	-	-	-	-	-	-	-	-
150-317	S03	-	-	320	320	-	-	-	-	-	320	320	-	-
150-401	S05	-	-	384	407	407	-	-	-	-	-	-	-	-
150-401	S06	-	-	407	407	-	-	-	-	-	-	-	-	-
200-401	S05	-	-	351	400	400	-	-	-	-	-	-	-	-
200-401	S06	-	-	400	-	-	-	-	-	-	-	-	-	-
200-500	S05	-	-	-	450	508	508	-	-	-	-	-	-	-
200-500Ex	S05	-	-	-	-	500	-	-	-	-	-	-	-	-
250-500	S06	-	-	-	-	475	-	-	-	-	-	-	-	-
250-500	S07	-	-	-	516	516	-	-	-	-	-	-	-	-
250-630	S07	-	-	-	540	-	-	-	-	-	-	-	-	-
250-630	S08	-	-	-	640	-	-	-	-	-	-	-	-	-
300-630	S07	-	-	-	530	640	640	-	-	-	-	-	-	-
300-630	S08	-	-	-	640	640	640	-	-	-	-	-	-	-
350-710	S07	-	-	-	-	740	740	740	-	-	-	-	-	-
350-710	S08	-	-	-	-	740	740	740	-	-	-	-	-	-

<sup>34</sup> Selection for a fluid density of 1.0 kg/dm<sup>3</sup> -1.2 kg/dm<sup>3</sup>; higher densities on request only

<sup>35</sup> For higher densities up to 1.2 kg/dm<sup>3</sup> max.: refer to the corresponding table to select the impeller diameter per bearing bracket and speed.

Nominal impeller diameters per bearing bracket and speed - for impeller type D

Table 12: Selection table<sup>36)</sup>

Size	Bearing bracket		50 Hz				60 Hz			
	Sewatec	Sewabloc	2900	1450	960	725	1750	1160	875	700
080-315	S03	-	-	260	-	-	-	-	-	-
080-315	S05	-	260	-	-	-	260	-	-	-
080-315	-	B03	-	260	-	-	-	-	-	-
080-316	S03	-	-	306	-	-	-	306	-	-
080-316	-	B03	-	306	-	-	-	306	-	-
080-317	S03	-	220	220	-	-	220	220	-	-
080-317	-	B03	220	220	-	-	220	220	-	-
100-253	S02	-	-	265	265	-	-	265	-	-
100-253	-	B02	-	265	265	-	-	265	-	-
100-315	S05	-	222	-	-	-	222	-	-	-
100-316	S03	-	-	306	-	-	-	306	-	-
100-316	-	B03	-	306	306	-	-	306	-	-
100-403	S04	-	-	408	408	-	-	408	-	-
100-403	S05	-	-	408	408	-	408	408	-	-
150-253	S02	-	-	254	254	-	-	254	-	-
150-253	-	B02	-	254	254	-	-	254	-	-
150-315	S03	-	-	317	317	-	-	317	317	-
150-315	-	B03	-	317	317	-	-	317	317	-
150-317 <sup>37)</sup>	S03	B03	-	309	309	-	309	309	-	-
150-400	S05	-	-	363	-	-	-	363	-	-
150-401	S05	-	-	-	412	-	-	-	-	-
150-401	S06	-	-	412	-	-	-	412	-	-
150-403	S04	-	-	340	408	-	-	408	-	-
150-403	S05	-	-	408	408	-	408	408	-	-
150-503 <sup>37)</sup>	S06	-	-	508	-	-	490	508	-	-
150-503 <sup>37)</sup>	S07	-	-	508	-	-	490	508	-	-
200-315	S03	-	-	315	315	-	-	315	315	-
200-315	-	B03	-	315	315	-	-	315	315	-
200-400	S05	-	-	-	402	-	-	-	-	-
200-400	S06	-	-	402	-	-	-	402	-	-
200-402	S04	-	-	-	408	-	-	408	-	-
200-402	S05	-	-	408	408	-	-	408	-	-
200-402	S06	-	-	408	408	-	-	408	-	-
200-405	S04	-	-	-	408	-	-	408	-	-
200-405	S05	-	-	408	408	-	-	408	-	-
200-405	S06	-	-	408	408	-	408	408	-	-
200-503 <sup>37)</sup>	S06	-	-	-	508	-	-	508	-	-
200-503 <sup>37)</sup>	S07	-	-	508	508	-	508	508	-	-
250-400	S05	-	-	-	375	-	-	-	375	-
250-400	S06	-	-	375	-	-	-	375	-	-
250-402	S04	-	-	-	408	-	-	-	408	-
250-402	S05	-	-	408	408	-	-	408	408	-
250-402	S06	-	-	408	408	-	-	408	408	-
300-400	S05	-	-	-	408	-	-	-	408	-
300-400	S06	-	-	408	-	-	-	408	-	-
300-402	S04	-	-	-	-	408	-	-	408	-
300-402	S05	-	-	-	408	408	-	408	408	-
300-402	S06	-	-	-	408	408	-	408	408	-
300-502 <sup>37)</sup>	S06	-	-	-	460	-	-	-	-	508
300-502 <sup>37)</sup>	S07	-	-	-	508	-	-	-	508	508
300-505 <sup>37)</sup>	S06	-	-	-	508	-	-	508	-	-

<sup>36)</sup> Selection for a fluid density of 1.0 kg/dm<sup>3</sup> -1.2 kg/dm<sup>3</sup>; higher densities on request only

<sup>37)</sup> Consult the manufacturer.

Size	Bearing bracket		50 Hz				60 Hz			
	Sewatec	Sewabloc	2900	1450	960	725	1750	1160	875	700
300-505 <sup>37)</sup>	S07	-	-	508	-	-	-	508	-	-
350-502 <sup>37)</sup>	S06	-	-	-	430	508	-	-	-	508
350-502 <sup>37)</sup>	S07	-	-	-	508	508	-	-	508	508
350-503 <sup>37)</sup>	S06	-	-	-	508	508	-	-	508	508
350-503 <sup>37)</sup>	S07	-	-	-	508	508	-	508	508	508

Nominal impeller diameters per bearing bracket and speed - for impeller type K

Table 13: Selection table<sup>38)</sup>

Size	Bearing bracket		50 Hz						60 Hz					
	Sewatec	Sewabloc	2900	1450	960	725	580	480	1750	1160	875	700	585	500
050-250	S01	-	-	260	260	-	-	-	-	260	260	-	-	-
050-250	-	B01	-	260	260	-	-	-	-	260	260	-	-	-
050-251	S02	-	265	-	-	-	-	-	265	-	-	-	-	-
050-251	-	B02	265	-	-	-	-	-	265	-	-	-	-	-
065-250	S01	-	-	230	230	-	-	-	-	230	230	-	-	-
065-250	-	B01	-	230	230	-	-	-	-	230	230	-	-	-
080-250	S01	-	-	235	-	-	-	-	-	235	-	-	-	-
080-250	-	B01	-	235	-	-	-	-	-	235	-	-	-	-
080-315	S03	-	220	-	-	-	-	-	220	-	-	-	-	-
080-315	-	B03	220	-	-	-	-	-	220	-	-	-	-	-
100-253	S02	-	-	256	-	-	-	-	256	256	-	-	-	-
100-253	-	B02	-	256	-	-	-	-	256	256	-	-	-	-
100-254	S01	-	-	256	-	-	-	-	-	-	-	-	-	-
100-254	-	B01	-	256	-	-	-	-	-	-	-	-	-	-
100-316	S03	-	-	312	-	-	-	-	312	-	-	-	-	-
100-316	-	B03	-	312	-	-	-	-	312	-	-	-	-	-
100-400	S04	-	-	408	408	-	-	-	-	408	408	-	-	-
100-400	S05	-	-	408	408	-	-	-	-	408	408	-	-	-
100-401	S04	-	-	404	404	-	-	-	-	404	404	-	-	-
100-401	S05	-	-	404	404	-	-	-	-	404	404	-	-	-
150-317	S03	-	-	309	309	-	-	-	309	309	-	-	-	-
150-317	-	B03	-	309	309	-	-	-	-	309	-	-	-	-
150-317	S05	-	-	309	309	-	-	-	309	309	-	-	-	-
150-400	S04	-	-	404	404	-	-	-	-	404	404	-	-	-
150-400	S05	-	-	404	404	-	-	-	-	404	404	-	-	-
150-403	S04	-	-	-	408	-	-	-	-	408	-	-	-	-
150-403	S05	-	-	408	408	-	-	-	408	408	-	-	-	-
150-503	S06	-	-	508	-	-	-	-	490	508	-	-	-	-
150-503	S07	-	-	508	-	-	-	-	490	508	-	-	-	-
151-403	S04	-	-	-	408	-	-	-	-	408	-	-	-	-
151-403	S05	-	-	408	408	-	-	-	408	408	-	-	-	-
200-315	S03	-	-	-	295	-	-	-	-	295	295	-	-	-
200-315	-	B03	-	-	295	-	-	-	-	295	295	-	-	-
200-316	S03	-	-	-	305	-	-	-	-	305	305	-	-	-
200-316	-	B03	-	-	305	-	-	-	-	305	305	-	-	-
200-317	S03	-	-	309	309	-	-	-	-	309	-	-	-	-
200-317	-	B03	-	309	309	-	-	-	-	309	-	-	-	-
200-317	S05	-	-	309	309	-	-	-	-	309	-	-	-	-
200-318	S03	-	-	309	-	-	-	-	-	309	-	-	-	-
200-318	-	B03	-	309	-	-	-	-	-	309	-	-	-	-
200-402	S04	-	-	408	408	-	-	-	-	408	408	-	-	-
200-402	S05	-	-	408	408	-	-	-	-	408	408	-	-	-
200-402	S06	-	-	408	408	-	-	-	-	408	408	-	-	-
200-403	S04	-	-	-	408	-	-	-	-	408	-	-	-	-
200-403	S05	-	-	408	408	-	-	-	-	408	-	-	-	-
200-403	S06	-	-	-	-	-	-	-	408	-	-	-	-	-
200-502	S06	-	-	-	508	-	-	-	-	508	-	-	-	-
200-502	S07	-	-	508	508	-	-	-	-	508	-	-	-	-
200-503	S06	-	-	-	504	-	-	-	-	504	-	-	-	-
200-503	S07	-	-	504	504	-	-	-	504	504	-	-	-	-
250-401	S04	-	-	380	404	-	-	-	-	404	404	-	-	-
250-401	S05	-	-	380	404	-	-	-	-	404	404	-	-	-
250-401	S06	-	-	404	-	-	-	-	-	-	-	-	-	-

2580.5/28-EN

<sup>38)</sup> Selection for a fluid density of 1.0 kg/dm<sup>3</sup> -1.2 kg/dm<sup>3</sup>; higher densities on request only

Size	Bearing bracket		50 Hz						60 Hz					
	Sewatec	Sewabloc	2900	1450	960	725	580	480	1750	1160	875	700	585	500
250-403	S04	-	-	-	408	408	-	-	-	408	408	-	-	-
250-403	S05	-	-	395	408	408	-	-	-	408	408	-	-	-
250-403	S06	-	-	408	-	-	-	-	408	-	-	-	-	-
250-632	S07	-	-	-	638	-	-	-	-	-	-	-	-	-
250-632	S08	-	-	-	-	-	-	-	-	638	-	-	-	-
250-900	S09	-	-	-	840	-	-	-	-	-	840	-	-	-
300-400	S04	-	-	-	388	388	388	-	-	-	388	388	-	-
300-400	S05	-	-	-	388	388	388	-	-	388	388	388	-	-
300-401	S04	-	-	-	408	408	408	-	-	-	408	408	-	-
300-401	S05	-	-	-	408	408	408	-	-	408	408	408	-	-
300-403	S05	-	-	-	408	408	408	-	-	408	408	408	-	-
300-500	S06	-	-	-	460	-	-	-	-	-	-	504	-	-
300-500	S07	-	-	-	504	-	-	-	-	-	504	504	-	-
300-505	S06	-	-	-	508	-	-	-	-	508	-	-	-	-
300-505	S07	-	-	508	-	-	-	-	-	508	-	-	-	-
350-500	S06	-	-	-	430	508	508	-	-	-	-	508	-	-
350-500	S07	-	-	-	508	508	508	-	-	-	508	508	-	-
350-503	S06	-	-	-	508	508	508	-	-	508	508	508	-	-
350-503	S07	-	-	-	508	-	-	-	-	-	-	-	-	-
350-632	S07	-	-	-	638	-	-	-	-	-	638	-	-	-
350-632	S08	-	-	-	638	-	-	-	-	-	638	-	-	-
350-633	S07	-	-	-	638	-	-	-	-	638	-	-	-	-
350-633	S08	-	-	-	-	-	-	-	-	638	-	-	-	-
350-710	S08	-	-	-	730	-	-	-	-	-	730	-	-	-
350-713	S08	-	-	-	738	-	-	-	-	620	-	-	-	-
350-713	S09	-	-	-	738	-	-	-	-	738	-	-	-	-
400-500	S06	-	-	-	-	501	508	-	-	-	464	508	-	-
400-500	S07	-	-	-	508	508	508	-	-	-	508	508	-	-
400-632	S08	-	-	-	638	638	-	-	-	-	638	-	-	-
400-710	S09	-	-	-	739	739	-	-	-	-	739	-	-	-
400-713	S09	-	-	-	738	-	-	-	-	738	738	-	-	-
400-900	S09	-	-	-	830	-	-	-	-	-	830	-	-	-
500-634	S07	-	-	-	626	626	626	-	-	-	626	626	626	-
500-634	S08	-	-	-	626	626	626	-	-	-	626	626	626	-
500-710	S09	-	-	-	739	-	-	-	-	-	739	-	-	-
500-900	S09	-	-	-	-	908	908	-	-	-	-	908	908	-
500-900	S10	-	-	-	-	908	908	-	-	-	-	908	908	-
600-520	S07	-	-	-	-	532	-	-	-	-	-	532	-	-
600-710	S08	-	-	-	-	715	715	-	-	-	-	715	715	-
600-900	S10	-	-	-	-	908	908	-	-	-	-	908	908	-
700-902	S08	-	-	-	-	-	904	904	-	-	-	904	904	904
700-902	S09	-	-	-	-	904	904	-	-	-	-	-	-	-

### Shaft seal

Table 14: Symbols key

Symbol	Description
X	Available
-	Not available
■	Non-standard

Table 15: Available shaft seal types per bearing bracket

Bearing bracket		Standard design		Standard variant <sup>39)</sup>		
Sewatec	Sewabloc	Mechanical seal with elastomer bellows (NBR, optional: Viton)40)	Stationary mechanical seal with spring outside of fluid (KSB 45TC)	KSB 4STQ double cartridge mechanical seal <sup>41)</sup>	Inboard mechanical seal with covered spring <sup>41)</sup>	Gland packing
S01	-	X	-	X	■	-
-	B01	X	-	X	■	-
S02	-	X	-	X	■	-
-	B02	X	-	X	■	-
S03	-	X	-	X	■	-
-	B03	X	-	X	■	-
S04	-	X	-	-	X	-
S05	-	X	-	■	X	X
S06	-	X	-	-	■	X
S07	-	X	-	-	■	X
S08	-	-	X	■	-	X
S09	-	-	X	■	-	X
S10	-	-	X	■	-	X

<sup>39)</sup> The selection of standard variants or special designs will determine whether surcharges or longer delivery times apply.

<sup>40)</sup> For all types of waste water

<sup>41)</sup> For very abrasive fluids or fluids containing metallic particles (e.g. shavings from drilling)

Technical data

Impeller type F

Table 16: Key to the symbols

Symbol	Description
■	Optional
X	Standard

Table 17: Overview

Size	Bearing bracket		Suction nozzle		Discharge nozzle		Pump data						Impeller type			
	Sewatec	Sewabloc					Torsional spring constant	Shaft seal		Pressure limits		Inspection hole diameter		Max. free passage	Max. impeller diameter	Min. impeller diameter
			Gland packing	Mechanical seal	Max. operating pressure	Max. test pressure		Casing	Flanged spacer							
	[mm]	[mm]	[Nm/impeller]	[bar]	[bar]	[mm]	[mm]	[mm]	[mm]	[mm]	[mm]	[mm]	[mm]	[kgm <sup>2</sup> ]		
050-215	S01	-	65	50	13000	-	X	10	15	-	80	42	210	130	0,09	
050-215	-	B01	65	50	13000	-	X	10	15	-	80	42	210	130	0,09	
050-216	S01	-	65	50	13000	-	X	10	15	-	80	25	210	120	0,025	
050-216	-	B01	65	50	13000	-	X	10	15	-	80	25	210	120	0,025	
065-215	S01	-	80	65	13000	-	X	6	9	-	80	65	210	120	0,025	
065-215	-	B01	80	65	13000	-	X	6	9	-	80	65	210	120	0,025	
065-217	S01	-	80	65	13000	-	X	7	10,5	-	80	65	200	120	0,02	
065-217	-	B01	80	65	13000	-	X	7	10,5	-	80	65	200	120	0,02	
080-215	S01	-	100	80	13000	-	X	6	9	-	120	76	200	120	0,025	
080-215	-	B01	100	80	13000	-	X	6	9	-	120	76	200	120	0,025	
080-216	S01	-	100	80	13000	-	X	7	10,5	-	120	80	210	120	0,025	
080-216	-	B01	100	80	13000	-	X	7	10,5	-	120	80	210	120	0,025	
080-217	S01	-	100	80	13000	-	X	6	9	-	120	76	200	120	0,025	
080-217	-	B01	100	80	13000	-	X	6	9	-	120	76	200	120	0,025	
080-252	S01	-	100	80	13000	-	X	6	9	-	120	76	210/250	150	0,095	
080-252	-	B01	100	80	13000	-	X	6	9	-	120	76	210/250	150	0,095	
080-253	S02	-	100	80	50000	-	X	8	12	-	120	76	265	150	0,14	
080-253	-	B02	100	80	50000	-	X	8	12	-	120	76	265	150	0,14	
080-317	S03	-	100	80	80000	-	X	10	15	-	120	76	240	150	0,14	
080-317	-	B03	100	80	80000	-	X	10	15	-	120	76	240	150	0,14	
100-215	S01	-	100	100	13000	-	X	6	9	100	120	100	210	120	0,025	
100-215	-	B01	100	100	13000	-	X	6	9	100	120	100	210	120	0,025	
100-251	S02	-	100	100	50000	-	X	6	9	118	120	100	265	249	0,119	
100-251	-	B02	100	100	50000	-	X	6	9	118	120	100	265	249	0,119	
100-252	S01	-	100	100	50000	-	X	6	9	118	120	100	210/265	170	0,119	
100-252	-	B01	100	100	50000	-	X	6	9	118	120	100	210/265	170	0,119	
100-253	S02	-	100	100	50000	-	X	6	9	118	120	100	265	249	0,119	
100-253	-	B02	100	100	50000	-	X	6	9	118	120	100	265	249	0,119	
100-254	S01	-	100	100	13000	-	X	6	9	118	120	100	210/265	170	0,119	
100-254	-	B01	100	100	13000	-	X	6	9	118	120	100	210/265	170	0,119	
100-316	S03	-	150	100	80000	-	X	6	9	90	150	100	310	236	0,075	
100-316	-	B03	150	100	80000	-	X	6	9	90	150	100	310	236	0,075	
100-401	S04	-	125	100	190000	-	X	10	15	120	120	100	390	325	0,475	
100-401	S05	-	125	100	220000	■	X	10	15	120	120	100	390	325	0,475	
150-315	S03	-	150	150	80000	-	X	6	9	118	150	120	290	250	0,214	
150-315	-	B03	150	150	80000	-	X	6	9	118	150	120	290	250	0,214	
150-401	S04	-	150	150	190000	-	X	10	15	120	200	135	390	325	0,475	
150-401	S05	-	150	150	220000	■	X	10	15	120	200	135	390	325	0,475	



**Impeller type E**
**Table 18: Key to the symbols**

Symbol	Description
■	Optional
✕	Standard

**Table 19: Overview**

Size	Bearing bracket		Pump data								Impeller type E				
			Suction nozzle		Discharge nozzle	Torsional spring constant	Shaft seal		Pressure limits		Inspection hole diameter		Max. free passage	Max. impeller diameter	Min. impeller diameter
	Sewatec	Sewabloc	[mm]	[mm]			[Nm/impeller]	Gland packing	Mechanical seal	Max. operating pressure	Max. test pressure	Casing			
			[mm]	[mm]	[mm]	[mm]	[bar]	[bar]	[mm]	[mm]	[mm]	[mm]	[mm]	[kgm <sup>2</sup> ]	
065-216	S02	-	80	65	50000	-	✕	6	9	-	80	65	183	140	0,02
065-216	-	B02	80	65	50000	-	✕	6	9	-	80	65	183	140	0,02
080-216	S02	-	100	80	50000	-	✕	7	10,5	-	120	76	210	160	0,035
080-216	-	B02	100	80	50000	-	✕	7	10,5	-	120	76	210	160	0,035
080-253	S02	-	100	80	50000	-	✕	6	9	-	120	76	270	210	0,14
100-250	S01	-	100	100	13000	-	✕	6	9	118	120	100	245	-	0,16
100-253	S02	-	150	100	50000	-	✕	6	9	118	120	76	270	210	0,17
100-253	-	B02	150	100	50000	-	✕	6	9	118	120	76	270	210	0,17
100-317	S03	-	125	100	80000	-	✕	7	10,5	85	120	76	328	286	0,25
100-401	S04	-	125	100	190000	-	✕	10	15	120	120	80	412	389	0,65
100-401	S05	-	125	100	220000	■	✕	10	15	120	120	80	412	389	0,65
150-317	S03	-	150	150	80000	-	✕	6	9	118	150	110	320	232	0,31
150-401	S05	-	150	150	220000	■	✕	10	15	120	200	135	407	348	0,68
150-401	S06	-	150	150	370000	■	✕	10	15	120	200	135	388	348	0,68
200-401	S04	-	200	200	190000	-	✕	10	15	120	200	135	388	348	0,68
200-401	S05	-	200	200	220000	■	✕	10	15	120	200	135	388	348	0,68
200-401	S06	-	200	200	370000	■	✕	10	15	200	200	135	407	348	0,68
200-500	S05	-	200	200	220000	■	✕	10	15	118	200	150	508	420	2,07
200-500Ex	S05	-	200	200	220000	■	✕	10	15	200	200	200	500	500	3,47
250-500	S06	-	250	250	370000	■	✕	10	15	200	200	180	516	454	3,22
250-500	S07	-	250	250	1020000	■	✕	10	15	200	200	180	516	454	3,22
250-630	S07	-	250	250	1020000	■	✕	10	15	200	143	196	640	540	6,56
250-630	S08	-	250	250	1400000	■	✕	10	15	200	143	196	640	540	6,56
300-630	S07	-	300	300	1020000	■	✕	10	15	200	200	220	640	530	7,25
300-630	S08	-	300	300	1400000	■	✕	10	15	200	200	220	640	530	7,25
350-710	S07	-	400	350	1020000	■	✕	6	9	200	200	280	740	670	15,21
350-710	S08	-	400	350	1400000	■	✕	6	9	200	200	280	740	670	15,21

**Impeller type D**
**Table 20: Key to the symbols**

Symbol	Description
■	Optional
x	Standard

**Table 21: Overview**

Size	Bearing bracket		Suction nozzle		Discharge nozzle		Pump data					Impeller type D				
	Sewatec	Sewabloc	[mm]	[mm]	Torsional spring constant	Shaft seal		Pressure limits		Inspection hole diameter	No. of impeller channels	Max. free passage	Max. impeller diameter	Min. impeller diameter	Moment of inertia J, based on water	
						Gland packing	Mechanical seal	Max. operating pressure	Max. test pressure							Casing
	[Nm/impeller]	[bar]	[bar]	[mm]	[mm]	[bar]	[bar]	[mm]	[mm]	[mm]	[mm]	[mm]	[mm]	[kgm <sup>2</sup> ]		
080-315	S03	-	100	80	80000	-	x	10	15	-	120	1	70	260	242	0,124
080-315	S05	-	100	80	220000	-	x	10	15	-	120	1	70	260	242	0,124
080-315	-	B03	100	80	80000	-	x	10	15	-	120	1	70	260	242	0,124
080-316	S03	-	125	80	80000	-	x	10	15	-	120	1	70	306	280	0,222
080-316	-	B03	125	80	80000	-	x	10	15	-	120	1	70	306	280	0,222
080-317	S03	-	100	80	80000	-	x	10	15	-	120	1	75	220	180	0,0471
080-317	-	B03	100	80	80000	-	x	10	15	-	120	1	75	220	180	0,0471
100-253	S02	-	150	100	50000	-	x	6	9	118	120	1	76	265	234	0,115
100-253	-	B02	150	100	50000	-	x	6	9	118	120	1	76	265	234	0,115
100-315	S05	-	125	100	220000	-	x	10	15	100	120	1	75	222	196	0,065
100-316	S03	-	150	100	80000	-	x	10	15	100	150	1	85	306	270	0,223
100-316	-	B03	150	100	80000	-	x	10	15	100	150	1	85	306	270	0,223
100-403	S04	-	200	100	190000	■	x	10	15	100	150	2	76	408	300	0,5
100-403	S05	-	200	100	220000	■	x	10	15	100	150	2	76	408	300	0,5
150-253	S02	-	150	150	50000	-	x	6	9	120	150	1	100	76	225	0,150
150-253	-	B02	150	150	50000	-	x	6	9	120	150	1	100	254	225	0,150
150-315	S03	-	150	150	80000	-	x	6	9	118	150	1	100	317	280	0,289
150-315	-	B03	150	150	80000	-	x	6	9	118	150	1	100	317	280	0,289
150-317 <sup>42)</sup>	S03	B03	200	150	80000	-	x	6	9	118	200	2	76	309	250	0,17
150-400	S05	-	200	150	220000	■	x	10	15	100	200	1	100	363	326	0,573
150-401	S05	-	250	150	220000	■	x	10	15	120	200	1	110	412	370	0,999
150-401	S06	-	250	150	370000	■	x	10	15	120	200	1	110	412	370	0,999
150-403	S04	-	200	150	190000	■	x	10	15	100	200	2	76	408	340	0,53
150-403	S05	-	200	150	220000	■	x	10	15	100	200	2	76	408	340	0,53
150-503 <sup>42)</sup>	S06	-	200	150	370000	■	x	11	16,5	118	200	2	76	508	400	1,13
150-503 <sup>42)</sup>	S07	-	200	150	102000	■	x	11	16,5	118	200	2	76	508	400	1,13
200-315	S03	-	200	200	80000	-	x	6	9	118	200	1	100	315	280	0,261
200-315	-	B03	200	200	80000	-	x	6	9	118	200	1	100	315	280	0,261
200-400	S05	-	250	200	220000	■	x	10	15	125	200	1	100	402	355	0,825
200-400	S06	-	250	200	370000	■	x	10	15	125	200	1	100	402	355	0,825
200-402	S04	-	250	200	190000	■	x	10	15	140	200	3	80	408	300	0,5
200-402	S05	-	250	200	220000	■	x	10	15	140	200	3	80	408	300	0,5
200-402	S06	-	250	200	370000	■	x	10	15	140	200	3	80	408	300	0,5
200-405	S04	-	250	200	190000	■	x	10	15	140	200	2	90	408	300	0,55
200-405	S05	-	250	200	220000	■	x	10	15	140	200	2	90	408	300	0,55
200-405	S06	-	250	200	370000	■	x	10	15	140	200	2	90	408	300	0,55
200-503 <sup>42)</sup>	S06	-	250	200	370000	■	x	10	15	118	200	2	90	508	400	1,2
200-503 <sup>42)</sup>	S07	-	250	200	102000	■	x	10	15	118	200	2	90	508	400	1,2
250-400	S05	-	250	250	220000	■	x	10	15	143	200	1	120	375	320	0,653

<sup>42)</sup> Consult the manufacturer.

Size	Bearing bracket		Suction nozzle	Discharge nozzle	Pump data								Impeller type D				
					Torsional spring constant	Shaft seal		Pressure limits		Inspection hole diameter		No. of impeller channels	Max. free passage	Max. impeller diameter	Min. impeller diameter	Moment of inertia J, based on water	
	Gland packing	Mechanical seal				Max. operating pressure	Max. test pressure	Casing	Flanged spacer								
						[Nm/impeller]	[bar]			[bar]	[mm]						[mm]
Sewatec	Sewabloc	[mm]	[mm]	[Nm/impeller]													
250-400	S06	-	250	250	370000	■	✗	10	15	143	200	1	120	375	320	0,653	
250-402	S04	-	250	250	190000	■	✗	10	15	143	200	3	106	398	300	0,6	
250-402	S05	-	250	250	220000	■	✗	10	15	143	200	3	106	398	300	0,6	
250-402	S06	-	250	250	370000	■	✗	10	15	143	200	3	106	398	300	0,6	
300-400	S05	-	300	300	220000	■	✗	10	15	143	200	1	150	408	375	0,925	
300-400	S06	-	300	300	370000	■	✗	10	15	143	200	1	150	408	375	0,925	
300-402	S04	-	300	300	190000	■	✗	10	15	143	200	3	100	408	300	0,63	
300-402	S05	-	300	300	220000	■	✗	10	15	143	200	3	100	408	300	0,63	
300-402	S06	-	300	300	370000	■	✗	10	15	143	200	3	100	408	300	0,63	
300-502 <sup>42)</sup>	S06	-	300	300	370000	■	✗	10	15	143	200	2	102	508	400	2,5	
300-502 <sup>42)</sup>	S07	-	300	300	102000	■	✗	10	15	143	200	2	102	508	400	2,5	
300-505 <sup>42)</sup>	S06	-	300	300	370000	■	✗	10	15	143	200	2	127	508	400	2,5	
300-505 <sup>42)</sup>	S07	-	300	300	102000	■	✗	10	15	143	200	2	127	508	400	2,5	
350-502 <sup>42)</sup>	S06	-	350	350	370000	■	✗	6	9	143	200	2	145	508	400	3,5	
350-502 <sup>42)</sup>	S07	-	350	350	102000	■	✗	6	9	143	200	2	145	508	400	3,5	
350-503 <sup>42)</sup>	S06	-	350	350	370000	■	✗	6	9	143	200	2	140	508	400	3,5	
350-503 <sup>42)</sup>	S07	-	350	350	102000	■	✗	6	9	143	200	2	140	508	400	3,5	

**Impeller type K**
**Table 22: Key to the symbols**

Symbol	Description
■	Optional
x	Standard

**Table 23: Overview**

Size	Bearing bracket		Suction nozzle		Discharge nozzle	Pump data						Impeller type K				
	Sewatec	Sewabloc				Torsional spring constant	Shaft seal		Pressure limits		Inspection hole diameter		No. of impeller channels	Max. free passage	Max. impeller diameter	Min. impeller diameter
			Gland packing	Mechanical seal	Max. operating pressure		Max. test pressure	Casing	Flanged spacer							
	[mm]	[mm]	[Nm/impeller]	[bar]	[bar]	[mm]	[mm]	[bar]	[bar]	[mm]	[mm]	[mm]	[mm]	[mm]	[kgm <sup>2</sup> ]	
050-250	S01	-	65	50	13000	-	x	10	15	-	80	3	15	260	150	0,05
050-250	-	B01	65	50	13000	-	x	10	15	-	80	3	15	260	150	0,05
050-251	S02	-	65	50	50000	-	x	10	15	-	80	3	15	256	150	0,05
050-251	-	B02	65	50	50000	-	x	10	15	-	80	3	15	256	150	0,05
065-250	S01	-	80	65	13000	-	x	6	9	-	80	2	50	230	170	0,08
065-250	-	B01	80	65	13000	-	x	6	9	-	80	2	50	230	170	0,08
080-250	S01	-	100	80	13000	-	x	6	9	-	120	2	71	235	205	0,08
080-250	-	B01	100	80	13000	-	x	6	9	-	120	2	71	235	205	0,08
080-315	S03	-	100	80	80000	-	x	10	15	-	120	2	33	220	140	0,07
080-315	S05	-	100	80	220000	-	x	10	15	-	120	2	33	220	140	0,07
080-315	-	B03	100	80	80000	-	x	10	15	-	120	2	33	220	140	0,07
100-253	S02	-	150	100	50000	-	x	6	9	118	120	2	76	256	200	0,15
100-253	-	B02	150	100	50000	-	x	6	9	118	120	2	76	256	200	0,15
100-254	S01	-	100	100	13000	-	x	6	9	118	120	2	71	256	210	0,07
100-254	-	B01	100	100	13000	-	x	6	9	118	120	2	71	256	210	0,07
100-316	S03	-	150	100	80000	-	x	6	9	90	150	2	76	309	235	0,13
100-316	-	B03	150	100	80000	-	x	6	9	90	150	2	76	309	235	0,13
100-400	S04	-	150	100	190000	-	x	10	15	100	150	2	76	408	355	1,1
100-400	S05	-	150	100	220000	■	x	10	15	100	150	2	76	408	355	1,1
100-401	S04	-	125	100	190000	-	x	10	13	120	120	2	50	404	310	0,50
100-401	S05	-	125	100	220000	■	x	10	13	120	120	2	50	404	310	0,50
150-317	S03	-	150	150	80000	-	x	6	9	100	150	2	76	309	250	0,28
150-317	S05	-	150	150	220000	■	x	6	9	100	150	2	76	309	250	0,28
150-317	-	B03	150	150	80000	-	x	6	9	100	150	2	76	309	250	0,28
150-400	S04	-	200	150	190000	-	x	10	15	100	200	3	76	404	300	0,83
150-400	S05	-	200	150	220000	■	x	10	15	100	200	3	76	404	300	0,83
150-403	S04	-	200	150	190000	-	x	10	15	100	200	2	76	408	340	0,691
150-403	S05	-	200	150	220000	■	x	10	15	100	200	2	76	408	340	0,691
150-503	S06	-	150	150	370000	■	x	10	15	118	150	2	76	508	400	0,91
150-503	S07	-	150	150	1020000	■	x	10	15	118	150	2	76	508	400	0,91
151-403	S04	-	200	150	190000	-	x	10	15	100	200	2	76	408	300	0,691
151-403	S05	-	200	150	220000	■	x	10	15	100	200	2	76	408	300	0,691
200-315	S03	-	200	200	80000	-	x	6	9	118	200	3	70	295	210	0,22
200-315	-	B03	200	200	80000	-	x	6	9	118	200	3	70	295	210	0,22
200-316	S03	-	200	200	80000	-	x	6	9	118	200	2	100	305	230	0,22
200-316	-	B03	200	200	80000	-	x	6	9	118	200	2	100	305	230	0,22
200-317	S03	-	200	200	80000	-	x	4	6	118	200	3	76	309	240	0,40
200-317	S05	-	200	200	220000	■	x	4	6	118	200	3	76	309	240	0,40
200-317	-	B03	200	200	80000	-	x	4	6	118	200	3	76	309	240	0,40
200-318	S03	-	200	200	80000	-	x	4	6	118	200	2	100	309	230	0,28
200-318	-	B03	200	200	80000	-	x	4	6	118	200	2	100	309	230	0,28

2580.5/28-EN

Size	Bearing bracket		Suction nozzle [mm]	Discharge nozzle [mm]	Pump data								Impeller type K				
	Sewatec	Sewabloc			Torsional spring constant [Nm/impeller]	Shaft seal		Pressure limits		Inspection hole diameter		No. of impeller channels	Max. free passage [mm]	Max. impeller diameter [mm]	Min. impeller diameter [mm]	Moment of inertia J, based on water [kgm <sup>2</sup> ]	
						Gland packing	Mechanical seal	Max. operating pressure [bar]	Max. test pressure [bar]	Casing [mm]	Flanged spacer [mm]						
																	-
200-401	S04	-	200	200	190000	-	✗	10	15	200	200	3	80	408	300	0,52	
200-402	S04	-	200	200	190000	-	✗	10	15	140	200	3	80	408	300	0,52	
200-402	S05	-	200	200	220000	■	✗	10	15	140	200	3	80	408	300	0,52	
200-402	S06	-	200	200	370000	■	✗	10	15	140	200	3	80	408	300	0,52	
200-403	S04	-	200	200	190000	-	✗	10	15	140	200	2	90	408	300	0,931	
200-403	S05	-	200	200	220000	■	✗	10	15	140	200	2	90	408	300	0,931	
200-502	S06	-	200	200	370000	■	✗	10,2	15	118	200	3	76	504	400	0,83	
200-502	S07	-	200	200	1020000	■	✗	10,2	15	118	200	3	76	504	400	0,83	
200-503	S06	-	200	200	370000	■	✗	10	15	118	200	2	90	504	400	1,636	
200-503	S07	-	200	200	1020000	■	✗	10	15	118	200	2	90	504	400	1,636	
250-401	S04	-	250	250	190000	-	✗	10	15	143	200	2	105	404	310	0,56	
250-401	S05	-	250	250	220000	■	✗	10	15	143	200	2	105	404	310	0,56	
250-401	S06	-	250	250	370000	■	✗	10	15	143	200	2	105	404	310	0,56	
250-403	S04	-	250	250	190000	-	✗	10	15	143	200	2	107	408	300	1,13	
250-403	S05	-	250	250	220000	■	✗	10	15	143	200	2	107	408	300	1,13	
250-403	S06	-	250	250	370000	■	✗	10	15	143	200	2	107	408	300	1,13	
250-632	S07	-	250	250	1020000	■	✗	11	16,5	143	200	3	105	638	500	5,684	
250-632	S08	-	250	250	1400000	■	✗	11	16,5	143	200	3	105	638	500	5,684	
250-900	S09	-	350	250	2500000	■	✗	13	19,5	100	-	3	110	840	717	19,03	
300-400	S04	-	300	300	190000	-	✗	10	15	143	200	3	100	388	332	0,75	
300-400	S05	-	300	300	220000	■	✗	10	15	143	200	3	100	388	332	0,75	
300-401	S04	-	300	300	190000	-	✗	10	15	143	200	2	135	408	367	0,75	
300-401	S05	-	300	300	220000	■	✗	10	15	143	200	2	135	408	367	0,75	
300-403	S05	-	300	300	220000	■	✗	10	15	143	200	2	110	408	300	1,439	
300-500	S06	-	300	300	370000	■	✗	6	9	143	200	3	100	504	430	1,48	
300-500	S07	-	300	300	1020000	■	✗	6	9	143	200	3	100	504	430	1,48	
300-505	S06	-	300	300	370000	■	✗	10	15	143	200	3	127	508	400	2,919	
300-505	S07	-	300	300	1020000	■	✗	10	15	143	200	3	127	508	400	2,919	
350-500	S06	-	350	350	370000	■	✗	6	9	143	200	3	110	508	393	3,12	
350-500	S07	-	350	350	1020000	■	✗	6	9	143	200	3	110	508	393	3,12	
350-503	S06	-	350	350	370000	■	✗	6	9	143	200	2	140	508	400	4,073	
350-503	S07	-	350	350	1020000	■	✗	6	9	143	200	2	140	508	400	4,073	
350-632	S07	-	350	350	1020000	■	✗	10	15	143	200	3	140	638	500	6,451	
350-632	S08	-	350	350	1400000	■	✗	10	15	143	200	3	140	638	500	6,451	
350-633	S07	-	350	350	1020000	■	✗	10	15	143	200	2	140	638	500	6,978	
350-633	S08	-	350	350	1400000	■	✗	10	15	143	200	2	140	638	500	6,978	
350-710	S08	-	400	350	1400000	■	✗	10	15	143	200	3	110	730	580	10,6	
350-713	S08	-	350	350	1400000	■	✗	13	19,5	143	200	2	125	738	580	14,557	
350-713	S09	-	350	350	1500000	■	✗	13	19,5	143	200	2	125	738	580	14,557	
400-500	S06	-	400	400	370000	■	✗	6	9	200	200	3	130	508	355	3,37	
400-500	S07	-	400	400	1020000	■	✗	6	9	200	200	3	130	508	355	3,37	
400-632	S08	-	500	400	1400000	■	✗	6	9	200	200	3	142	638	527	9,074	
400-710	S09	-	500	400	2500000	■	✗	10	15	150	200	3	145	739	587	16,0	
400-713	S09	-	500	400	2500000	■	✗	8	13,5	200	200	2	145	738	580	15,894	
400-900	S09	-	500	400	2500000	■	✗	13	19,5	143	-	3	125	830	659	17,79	
500-634	S07	-	500	500	1020000	■	✗	5	7,5	200	200	3	132	638	500	9,503	
500-634	S08	-	500	500	1400000	■	✗	5	7,5	200	200	3	132	638	500	9,503	
500-710	S09	-	500	500	2500000	■	✗	8	12	200	-	3	150	700	586	16,0	
500-900	S09	-	600	500	2500000	■	✗	9	13,5	200	-	3	178	908	721	45,0	

Size	Bearing bracket		Pump data										Impeller type K				
	Sewatec	Sewabloc	Suction nozzle		Discharge nozzle	Torsional spring constant	Shaft seal		Pressure limits		Inspection hole diameter		No. of impeller channels	Max. free passage	Max. impeller diameter	Min. impeller diameter	Moment of inertia J, based on water
			[mm]	[mm]			[Nm/impeller]	Gland packing	Mechanical seal	Max. operating pressure	Max. test pressure	Casing					
	[bar]	[bar]	[mm]	[mm]	[kgm <sup>2</sup> ]												
500-900	S10	-	600	500	5000000	■	✗	9	13,5	200	-	3	178	908	721	45,0	
600-520	S07	-	500	600	1020000	■	✗	4	6	200	200	3	145	532	457	7,02	
600-710	S08	-	600	600	1400000	■	✗	4	6	200	200	3	165	736	664	16,96	
600-900	S10	-	700	600	5000000	■	✗	9	13,5	200	-	3	180	908	760	50,0	
700-902	S08	-	800	700	1400000	■	✗	3,5	5	200	200	3	190	904	738	40,0	
700-902	S09	-	800	700	1500000	■	✗	4,7	6,11	200	200	3	190	904	738	40,0	

### Speeds for Sewatec 3H

As standard, electric motors of B5/V1 type of construction are used up to 200 L, and B3 type of construction for 225 S and larger.

**Table 24:** Pump speeds of Sewatec 3H [rpm]

Characteristic		Value													
Transmission ratio [ i ]		1,0	1,06	1,12	1,2	1,25	1,34	1,4	1,5	1,6	1,7	1,8	1,9	2,0	
n <sub>M</sub> [rpm]	960	-	-	-	-	-	-	685	640	600	565	535	505	480	
	1450	1450	1540	1620	1740	1810	1940	2030	2180	2320	2470	2610	2760	2900	
		1450	1370	1295	1210	1160	1080	1035	965	905	850	805	765	725	
	2900	2900	2735	2590	2415	2320	2165	2070	1935	1815	1705	1610	1525	1450	

**Note:**

- Refer to the speed curves for the maximum permissible speed.
- F, E and D impellers cannot be trimmed. They are available in several sizes for each nominal diameter.
- K impellers can be trimmed. For reasons of efficiency it is preferable to adjust the pump set to the duty point by means of the above transmission ratios.
- The maximum transmission ratio equals 2:1.
- 4-pole motors should be preferred to 2-pole motors as they have lower running noises.
- For cost reasons 4-pole motors are preferable to motors with more than 4 poles.
- Flywheels can be fitted, if the specified centre distances and pulley diameters are observed.

### Motor ratings

**Table 25:** Motor ratings, 50 Hz

Motor size	Motor rating to IEC IP 55 [kW] <sup>43)</sup>			
	50 Hz			
	2900 rpm	1450 rpm	960 rpm	750 rpm
100 L	3	2,2 3	1,5	0,75 1,1
112 M	4	4	2,2	1,5
132 S	5,5 7,5	5,5	3	2,2
132 M	-	7,5	4 5,5	3
160 M	11 15	11	7,5	4 5,5
160 L	18,5	15	11	7,5
180 M	22	18,5	-	-
180 L	-	22	15	11
200 L	30 37	30	18,5 22	15
225 S	-	37	-	18,5
225 M	45	45	30	22
250 M	55	55	37	30
280 S	75	75	45	37
280 M	90	90	55	45
315 S	110	110	75	55
315 M	132	132	90	75
315 L	-	160 200	110 132 160 200	90 110 132
315 (Siemens 1LA8)	-	250 315	250	160 200

<sup>43)</sup> The motor ratings per motor size may differ, depending on the make.

Motor size	Motor rating to IEC IP 55 [kW] <sup>43)</sup>			
	50 Hz			
	2900 rpm	1450 rpm	960 rpm	750 rpm
355 (Siemens 1LA8)	-	355 400 500	315 355 400	250 315
400 (Siemens 1LA8)	-	560 630 710	450 500 560	355 400 425 450
450 (Siemens 1LA8)	-	-	615 630 690	485 500 545 560 600 630

**Table 26:** Motor ratings, 60 Hz

Motor size	Motor rating to <sup>43)</sup> nach IEC IP 55 [kW]		
	1750 rpm	1160 rpm	875 rpm
100 L	2,55 3,45	1,75	1,3
112 M	4,55	2,55	1,75
132 S	6,3	3,45	2,55
132 M	8,6	4,6 6,3	3,45
160 M	12,6	8,6	4,6 6,3
160 L	17,3	12,6	8,6
180 M	18,5	-	-
180 L	25,3	18	13,2
200 L	34,5	22 26,5	18
225 S	42,5	-	22
225 M	52	36	26,5
250 M	63	44,5	36
280 S	86	54	44,5
280 M	104	66	54
315 S	127	90	66
315 M	152	108	90
315 L	184 230 300 400	132 158 192 240	108 132 158
315 (Siemens 1LA8)	288 362	-	-
355 (Siemens 1LA8)	408 460 575	-	-
400 (Siemens 1LA8)	644 725	-	-

**Power reserve**

Pump input power	Recommended power reserve for the drive
[kW]	[%]
≤ 7,5	≈ 30 (≥ 1 kW)
> 7,5 to 22	≈ 20
> 22 to 55	≈ 15
> 55	≈ 10



Selection charts

Sewatec/Sewabloc F + \*F-max, n = 2900-960 rpm (speed-based selection chart)

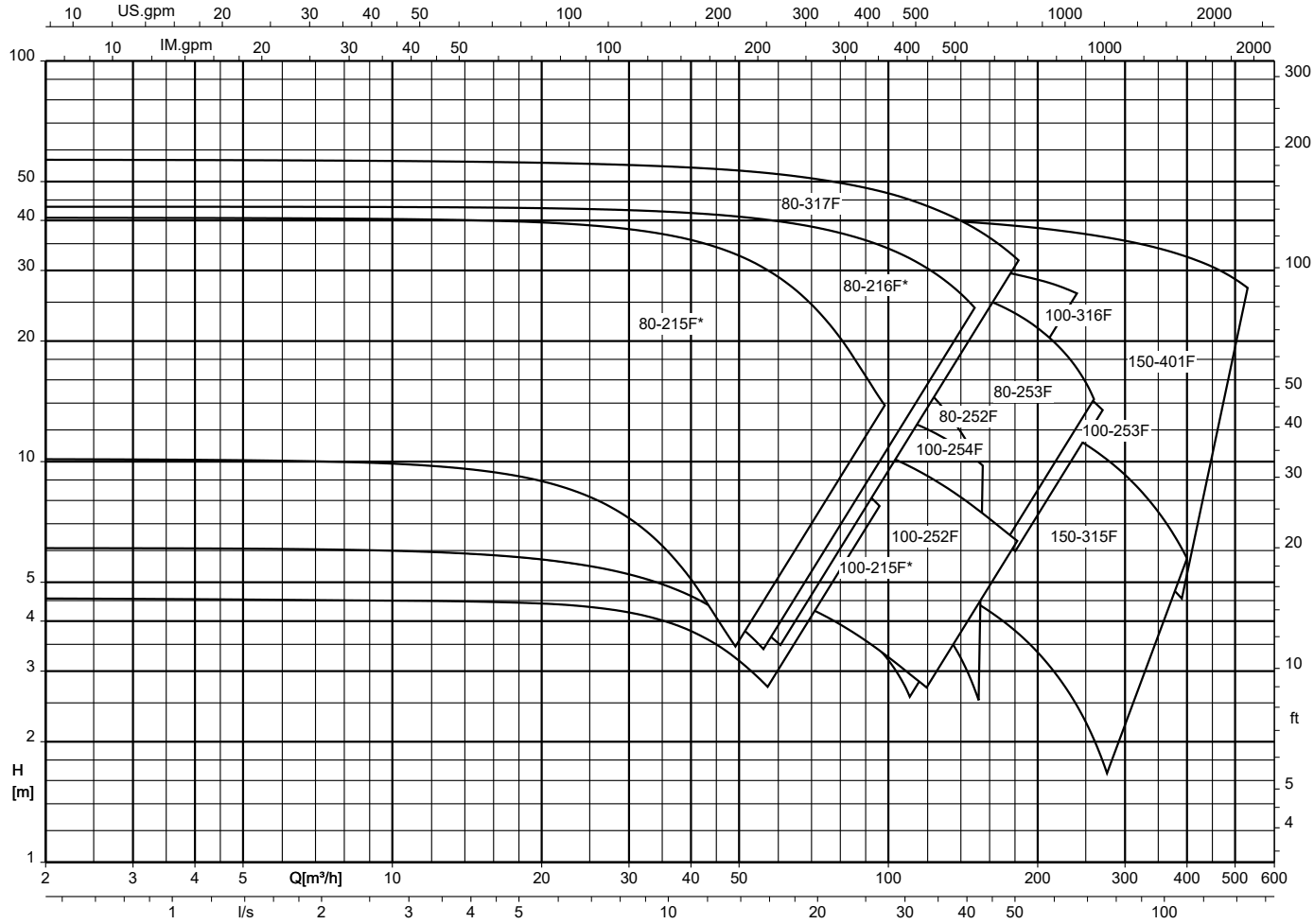

Sewatec/Sewabloc F + \*F-max, n = 2900/1450/960 rpm (diameter-based selection chart)

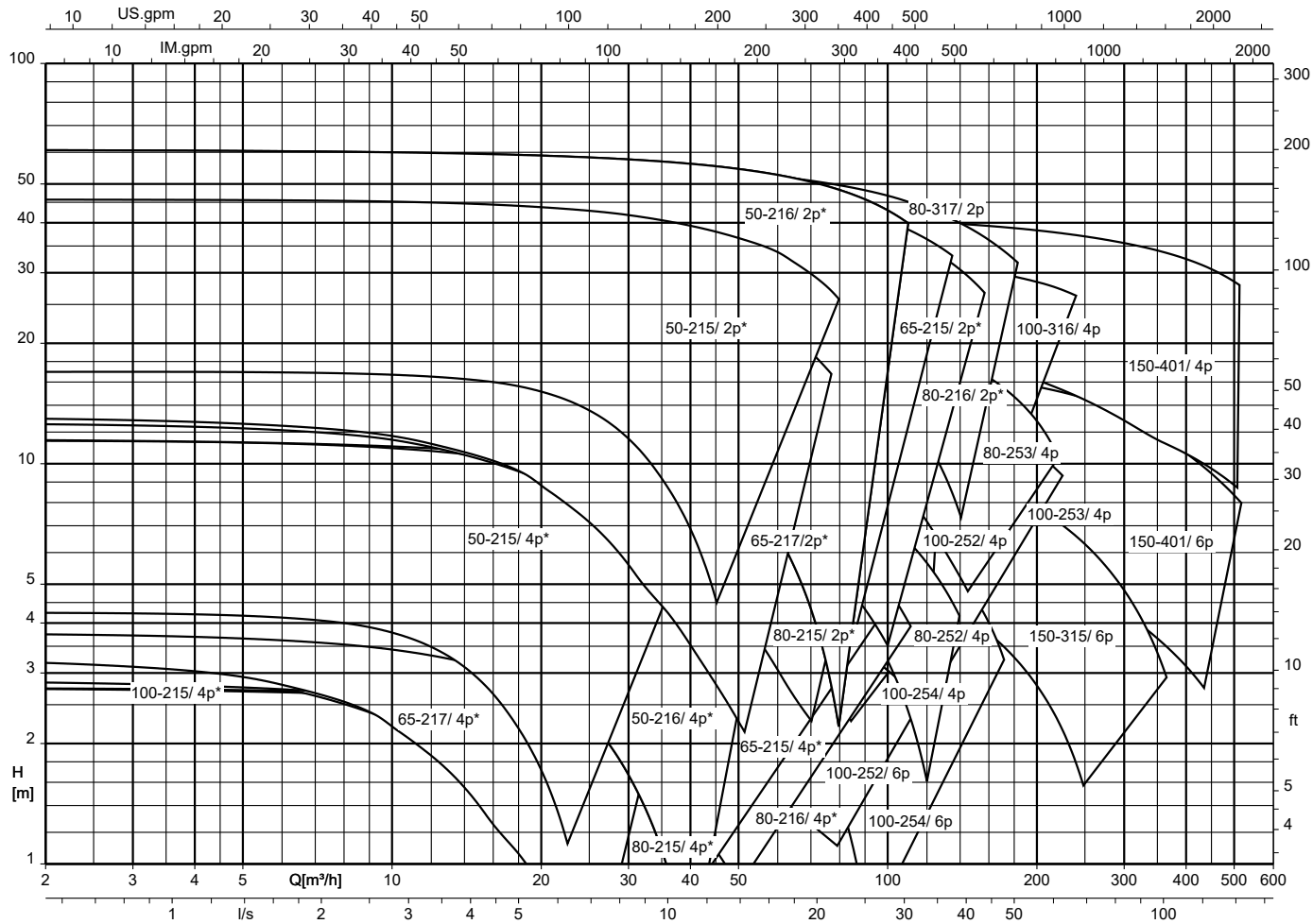

Sewatec/Sewabloc E + \*E-max, n = 1450-480 rpm (speed-based selection chart)

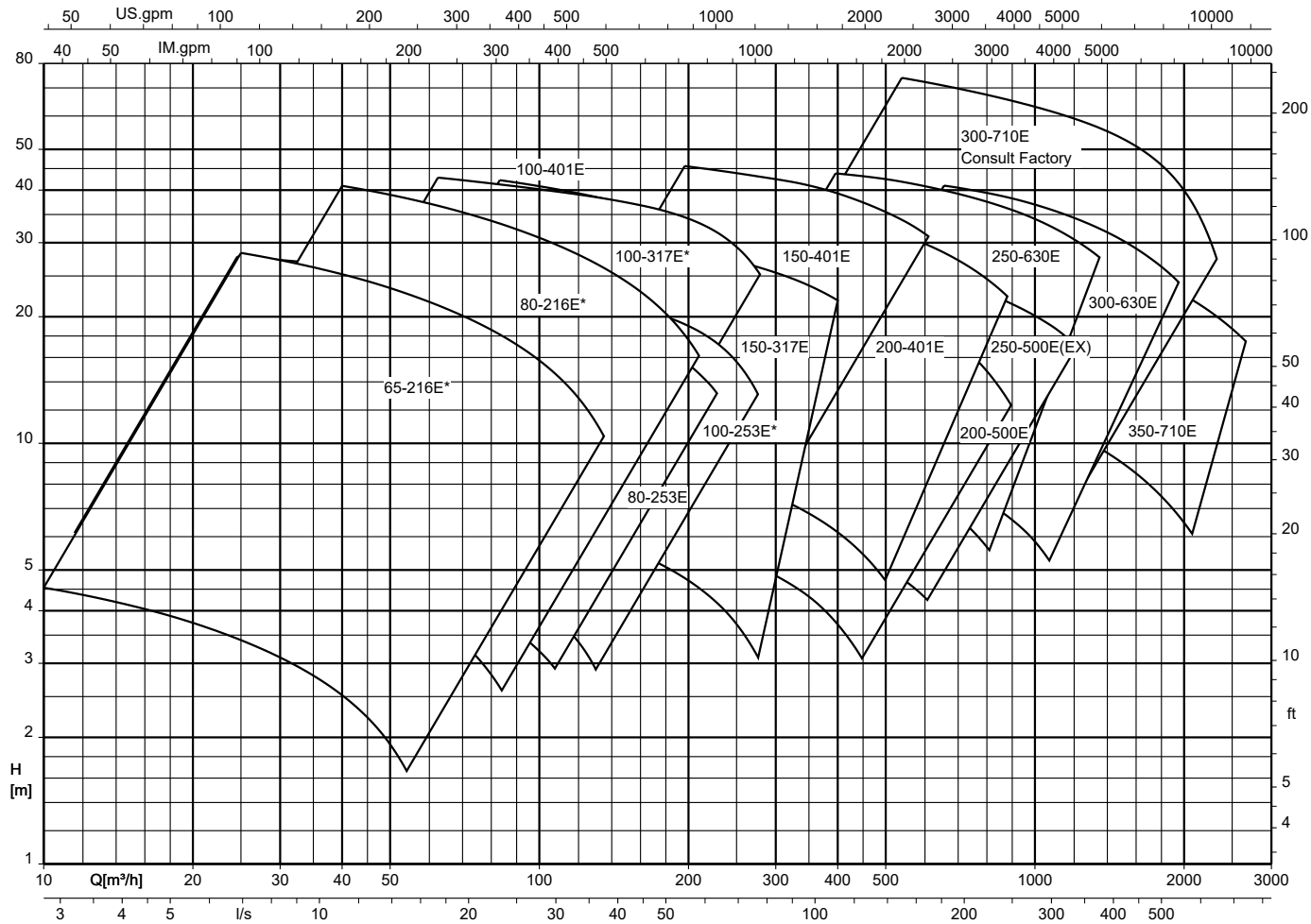

Sewatec/Sewabloc E + \*E-max, n = 1450/960/725/580/480 rpm (diameter-based selection chart)

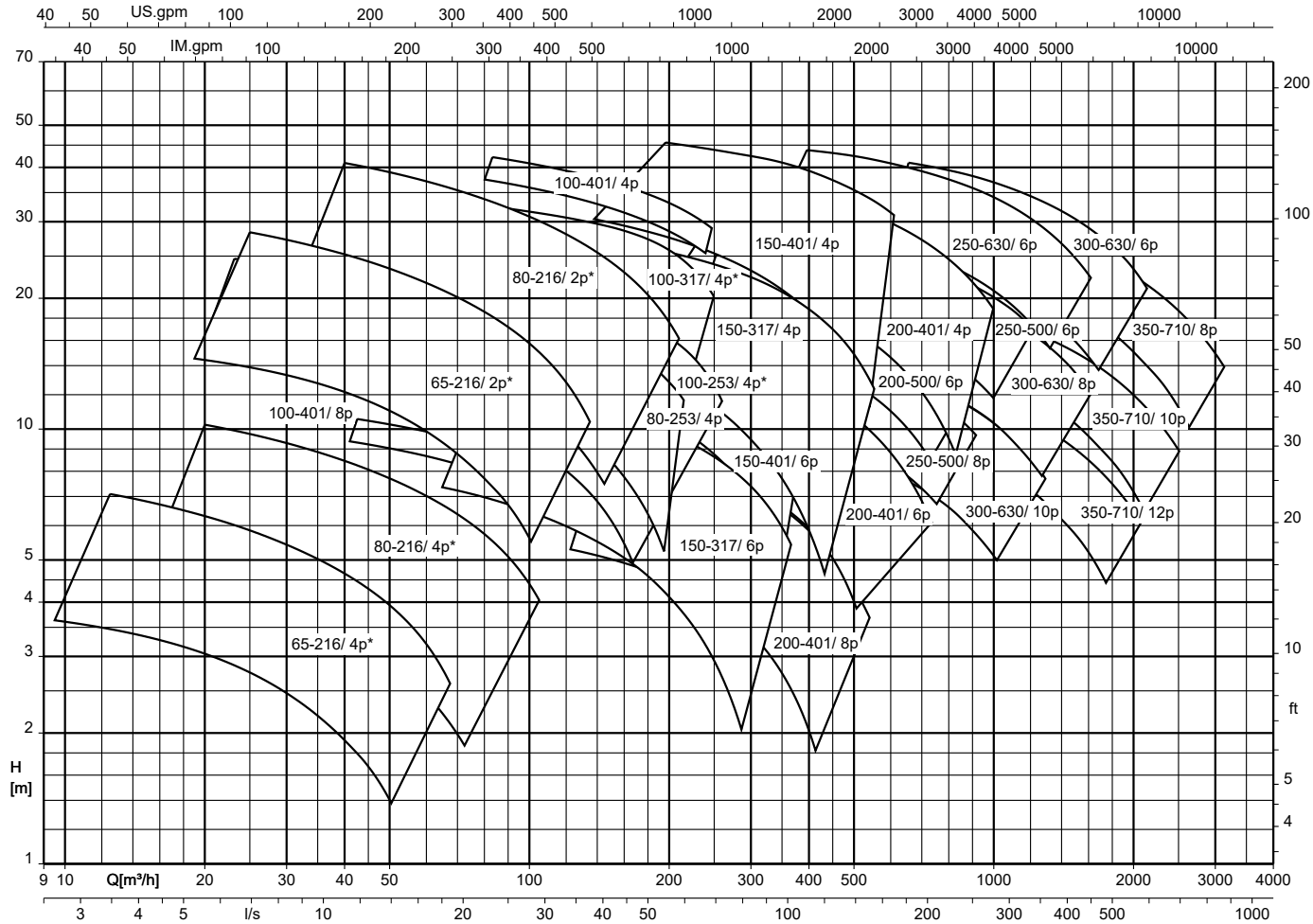

Sewatec/Sewabloc D, n = 2900-960 rpm (speed-based selection chart)

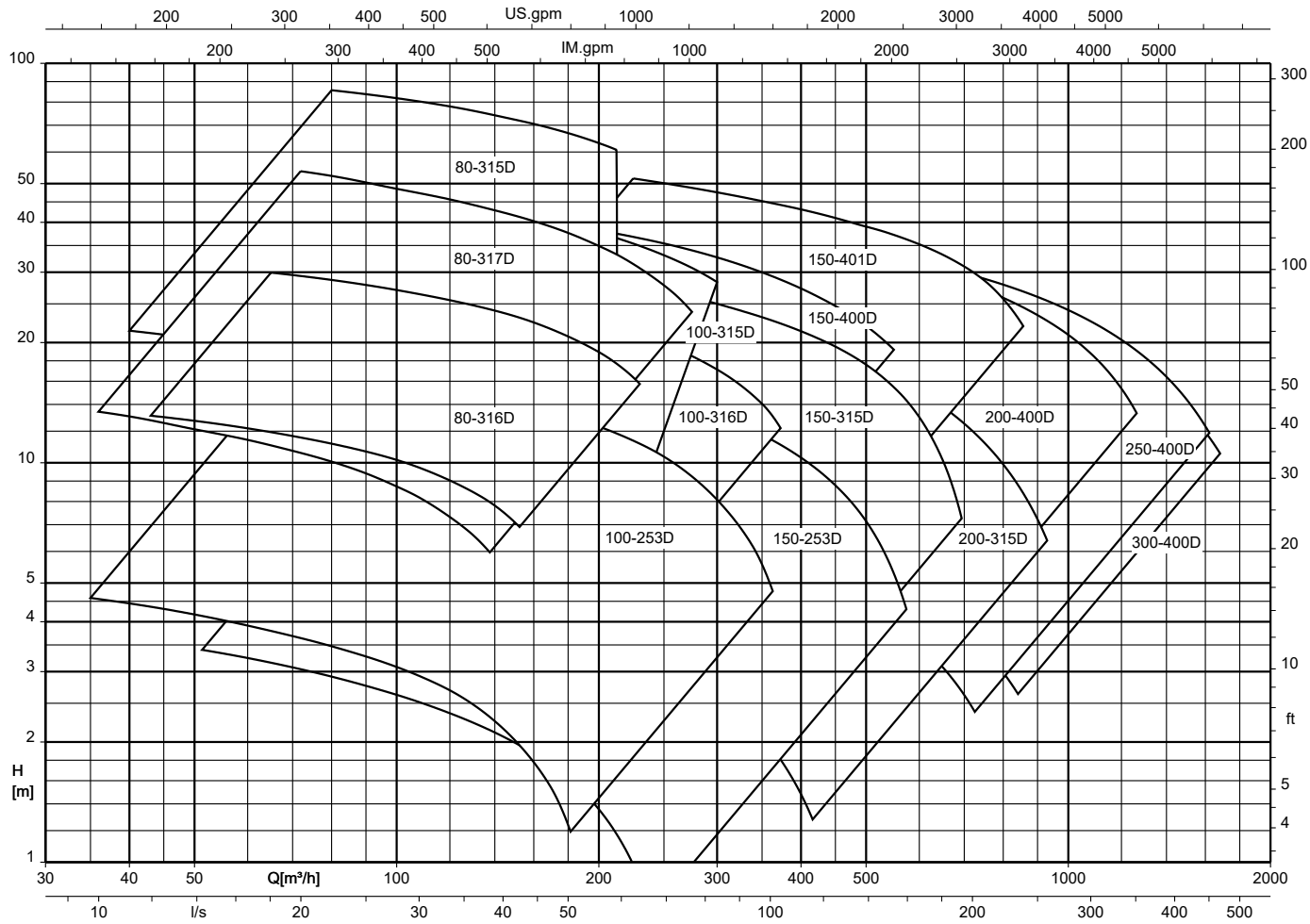

Sewatec/Sewabloc D, n = 2900/1450/960 rpm (diameter-based selection chart)

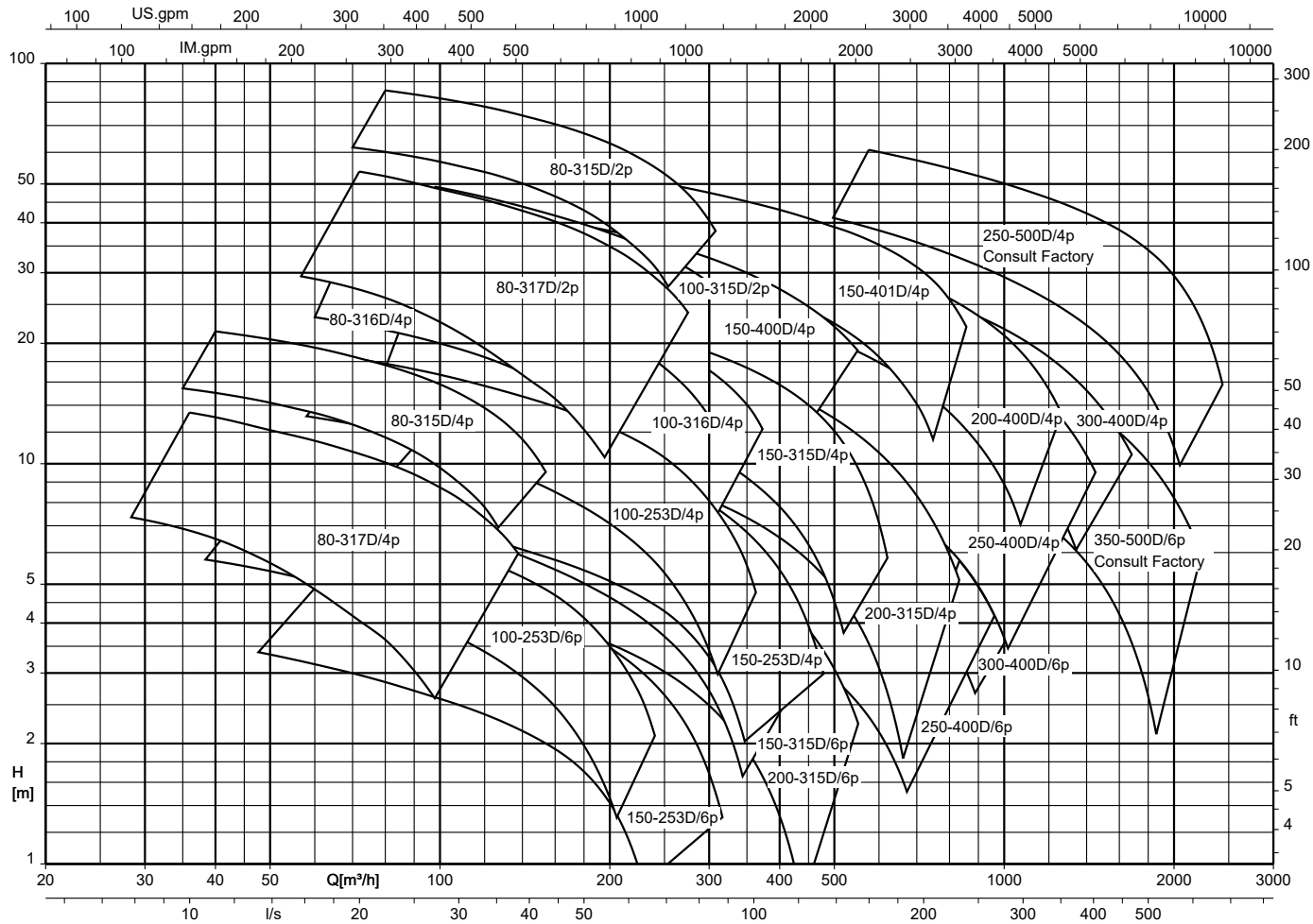

Sewatec \*D-max, n = 1450/960/725 rpm (diameter-based selection chart)

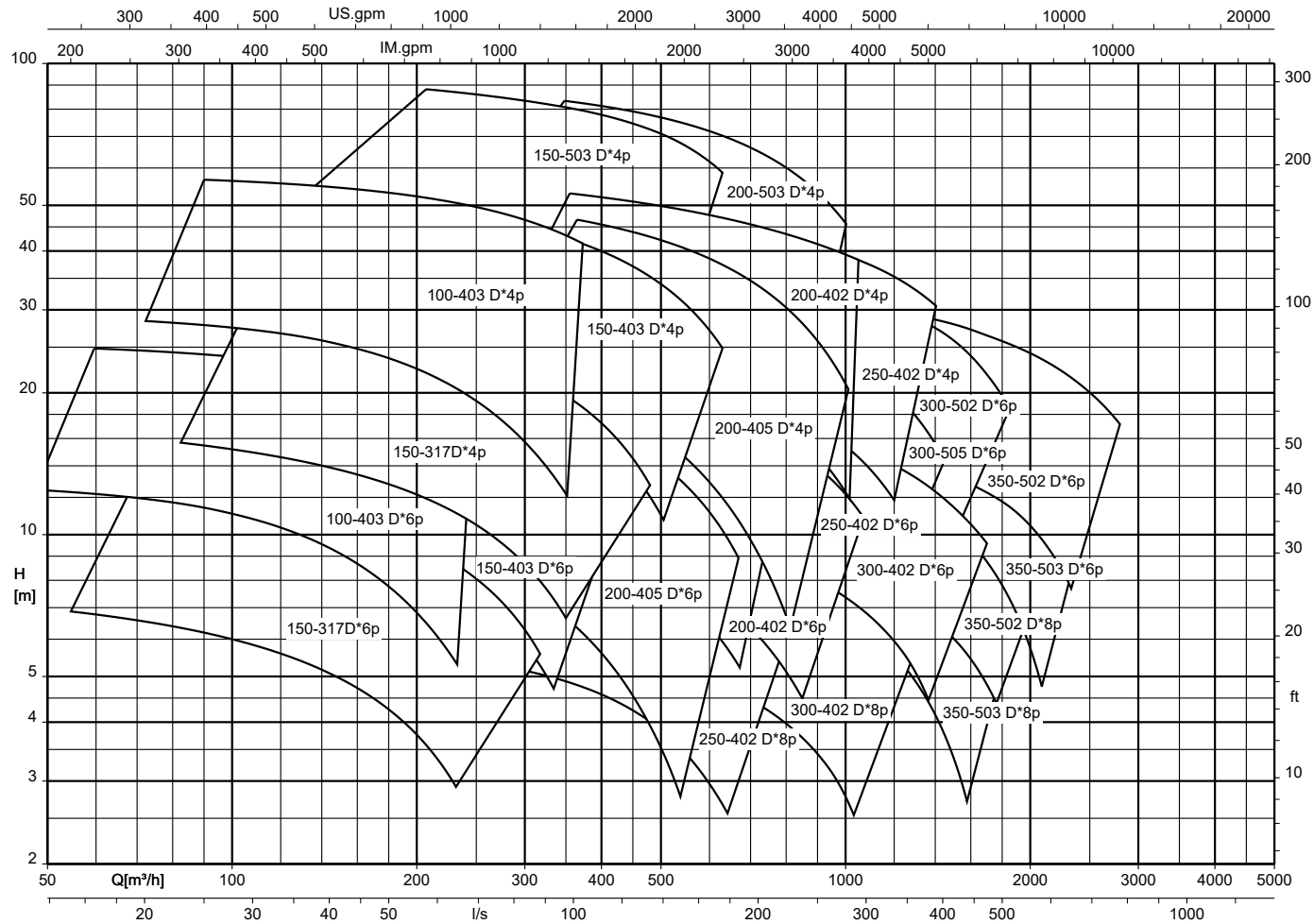

D 150-317, D 150-503, D 200-503, D 300-502, D 300-505, D 350-502, D 350-503:

Consult the manufacturer.

Sewatec/Sewabloc K + \*K-max, n = 2900-480 rpm (speed-based selection chart)

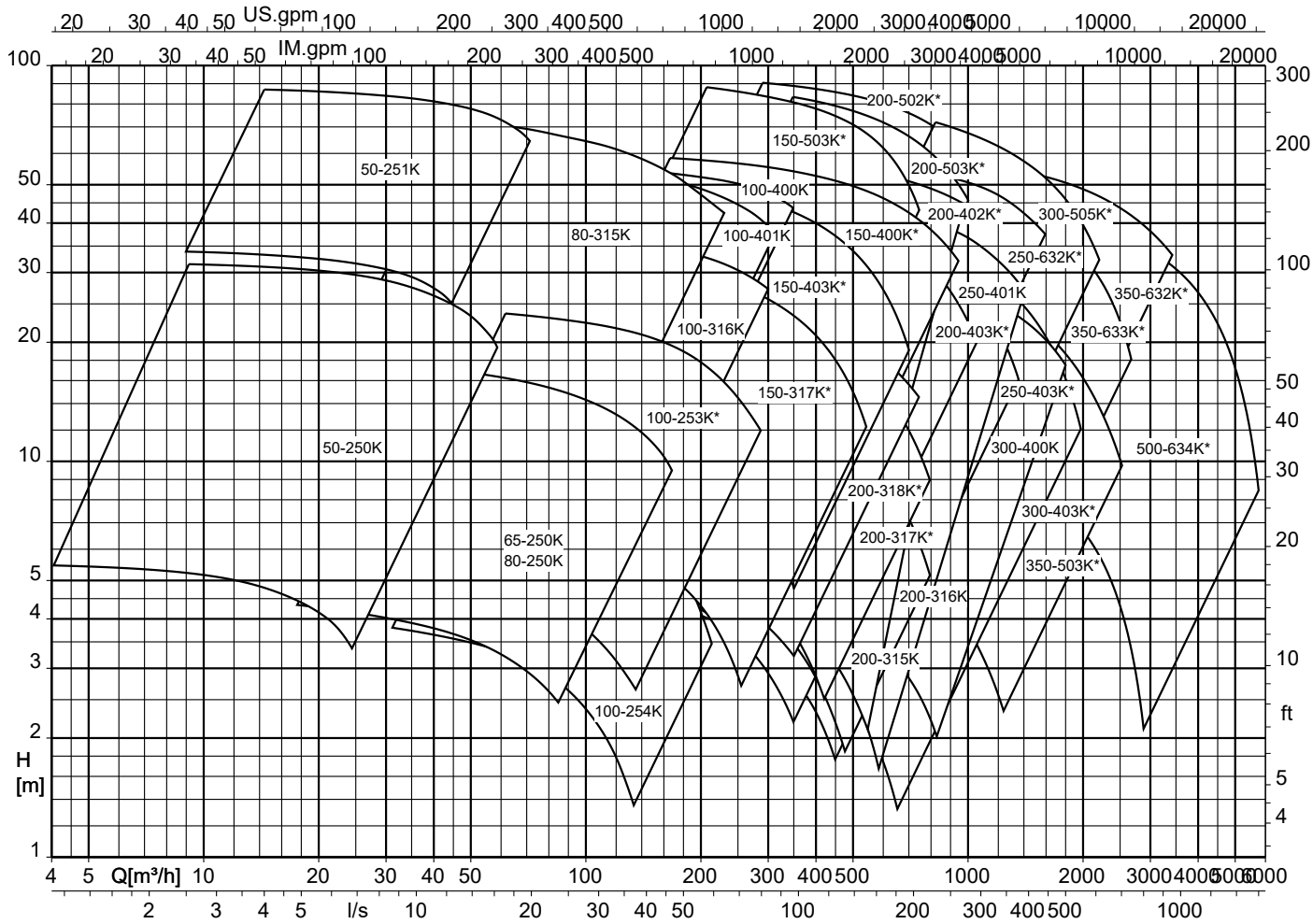



Sewatec/Sewabloc K + \*K-max, n = 2900/1450 rpm (diameter-based selection chart)

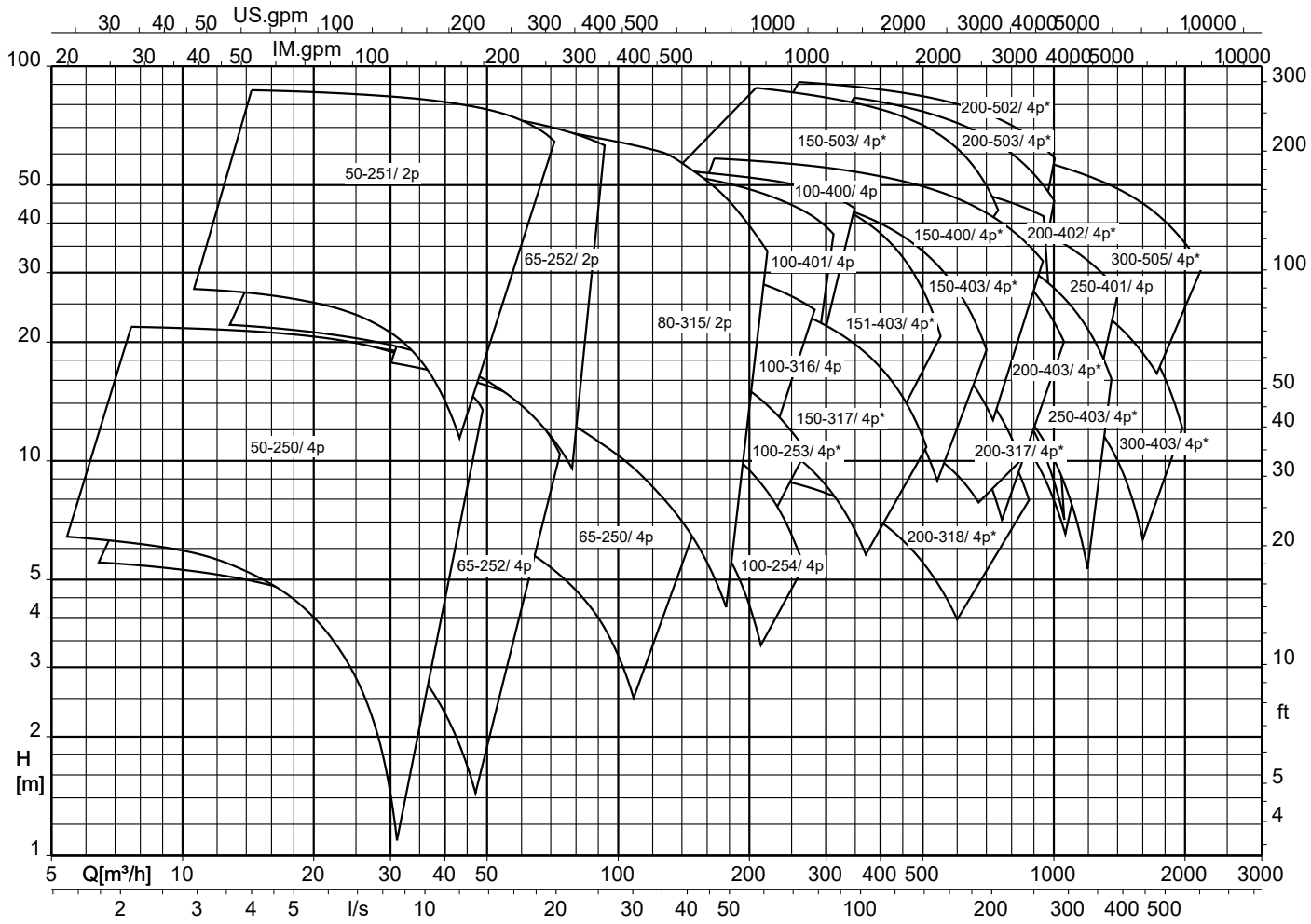

Sewatec/Sewabloc K + \*K-max, n = 960 rpm (diameter-based selection chart)

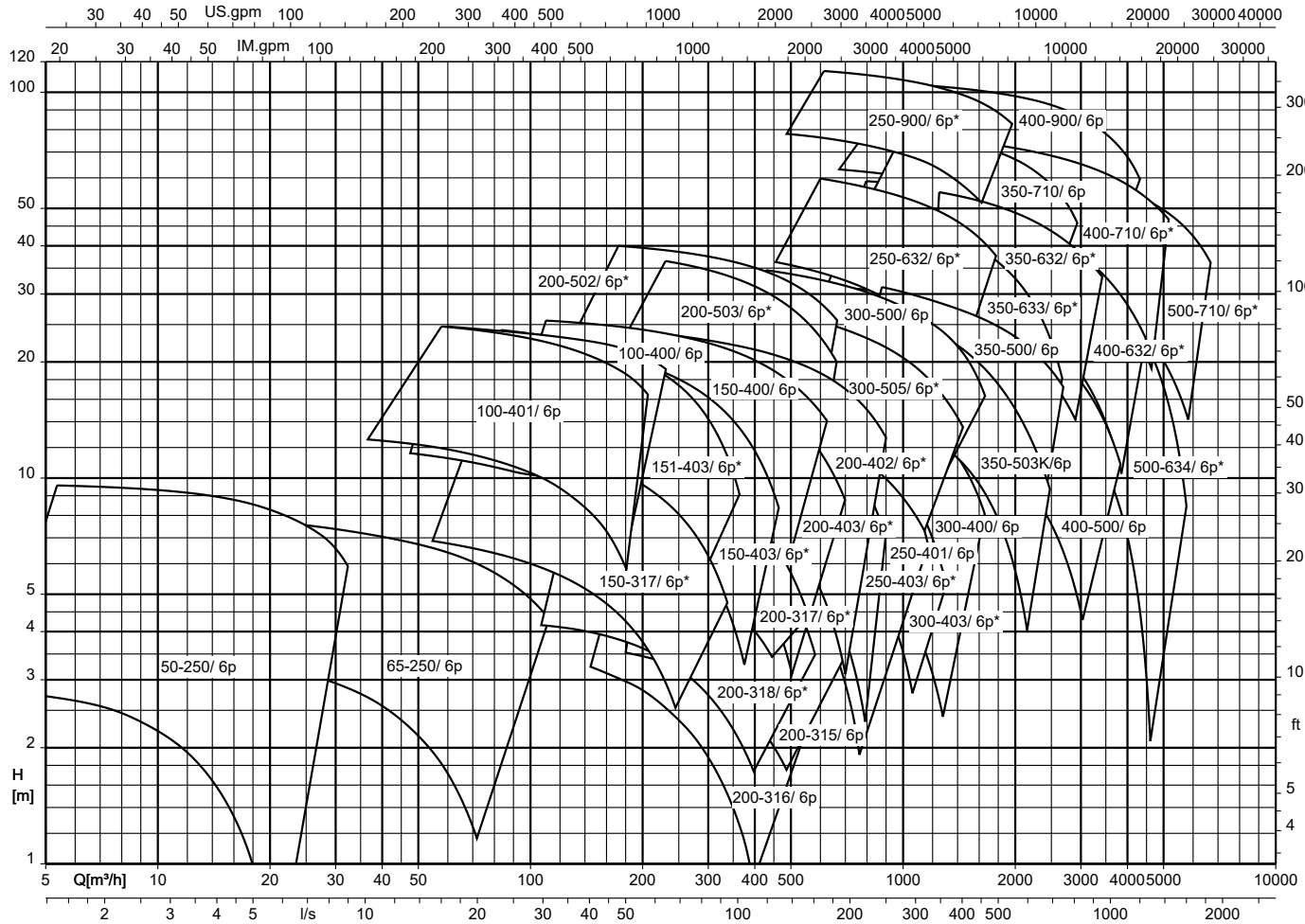

Sewatec K + \*K-max, n = 725 rpm (diameter-based selection chart)

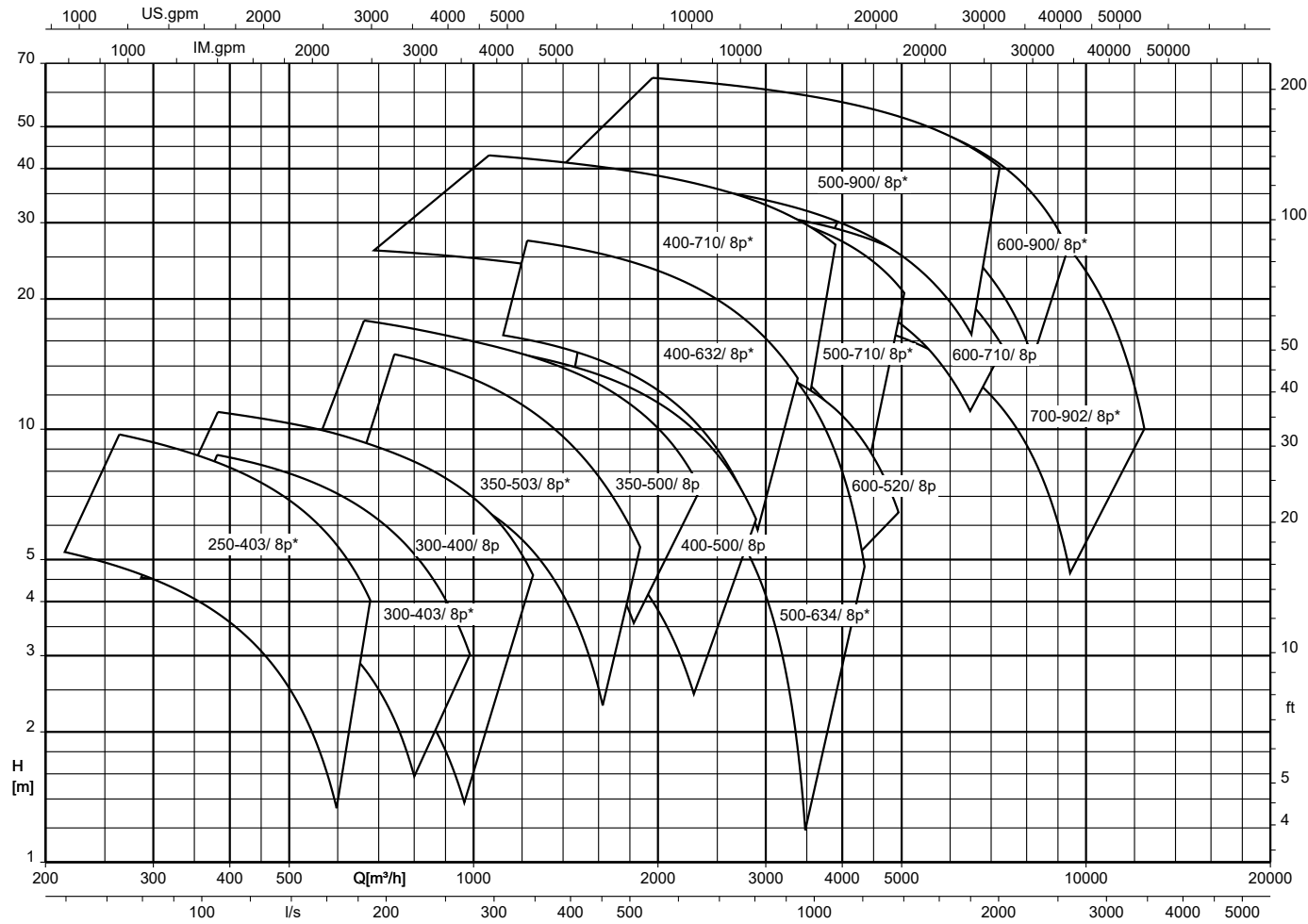

Sewatec K + \*K-max, n = 580/480 rpm (diameter-based selection chart)

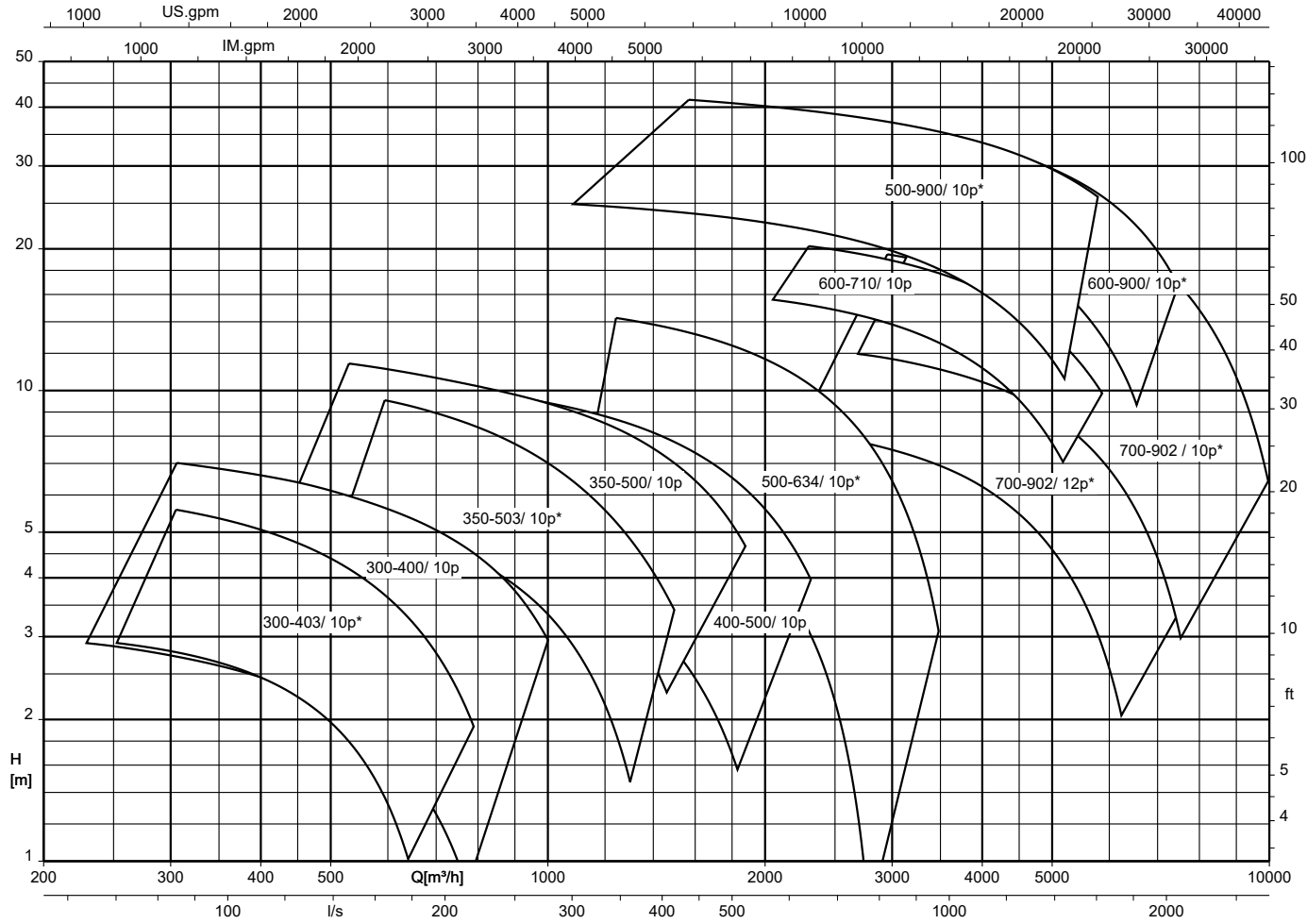

Types of installation

Horizontal installation

Sewatec - Fig. 0

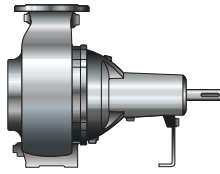

Bare-shaft pump

Sewatec - 3H (3HZ)

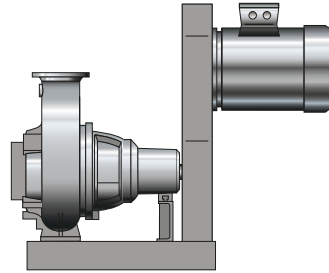

Pump set with baseplate, belt drive and belt guard

Sewatec - 3H (3HM)

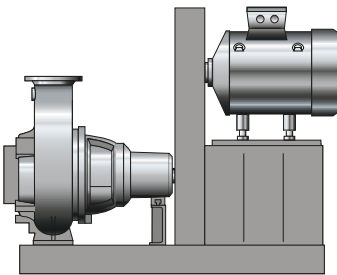

Pump set with baseplate, belt drive, belt guard and motor stand

Sewatec - 3H with countershaft (3HVG)

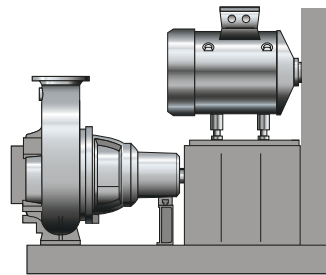

Pump set with baseplate, coupling (also with coupling spacer), coupling guard, countershaft stand, countershaft, motor stand, belt drive and belt guard

Sewatec - 3E (3EN/3ENH)

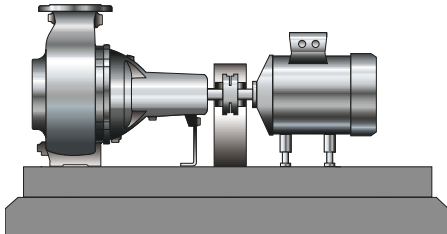

Pump set with directly coupled drive, baseplate, coupling (also with coupling spacer), coupling guard and height adjustment of the motor

Sewabloc

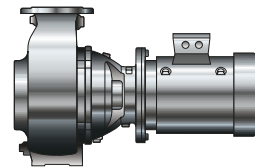

Pump set with directly flanged motor (B5/V1 type of construction)

Vertical installation

Sewatec - vertical (V)

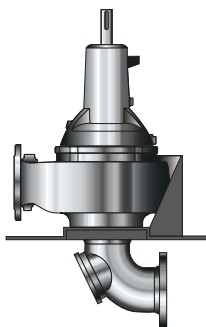

Bare-shaft pump, soleplate and suction elbow

Sewatec - vertical (VU)

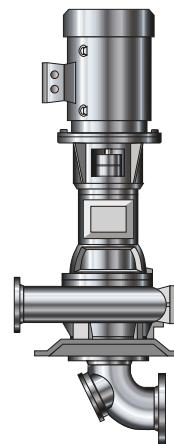

Pump set with soleplate, drive lantern, coupling, coupling guard and suction elbow

Sewatec - vertical (VGW)

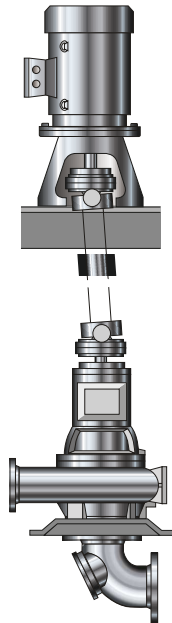

Pump set with soleplate for pump and motor, supporting frame, drive lantern, suction elbow and universal-joint shaft

Sewabloc - vertical (V)

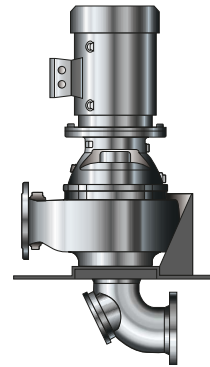

Pump set with directly flanged motor (B5/V1 type of construction), with soleplate and suction elbow, for underfloor installation

Sewabloc - vertical (VF)

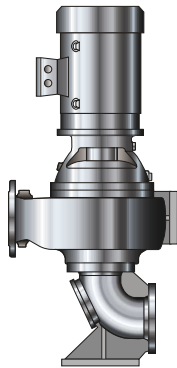

Pump set with directly flanged motor (B5/V1 type of construction), with suction duckfoot bend

Installation types per bearing bracket and impeller type

Table 27: Installation types per bearing bracket and impeller type

Size	Bearing bracket	Impeller type	Installation types												
			Sewabloc			Sewabloc-vertical		Sewatec						Sewatec-vertical	
BLOC	BLOC-V	BLOC-VF	Fig. 0	3EN	3ENH	3HZ	3HM	3HVG-N	3HVG-NH	V	VU	VGW			
050-215	B01	F	X	X	X	-	-	-	-	-	-	-	-	-	
050-215	S01	F	-	-	-	X	X	X	-	-	-	-	X	-	
050-216	B01	F	X	X	X	-	-	-	-	-	-	-	-	-	
050-216	S01	F	-	-	-	X	X	X	-	-	-	-	X	-	
050-250	S01	K	-	-	-	X	X	X	X	-	-	-	X	-	
050-250	B01	K	X	X	X	-	-	-	-	-	-	-	-	-	
050-251	S02	K	-	-	-	X	X	X	X	-	-	-	X	-	
050-251	B02	K	X	X	X	-	-	-	-	-	-	-	-	-	
065-215	B01	F	X	X	X	-	-	-	-	-	-	-	-	-	
065-215	S01	F	-	-	-	X	X	X	-	-	-	-	X	-	
065-216	S02	E	-	-	-	X	X	X	X	-	-	-	X	-	
065-216	B02	E	X	X	X	-	-	-	-	-	-	-	-	-	
065-217	B01	F	X	X	X	-	-	-	-	-	-	-	-	-	
065-217	S01	F	-	-	-	X	X	X	-	-	-	-	X	-	
065-250	S01	K	-	-	-	X	X	X	X	-	-	-	X	-	
065-250	B01	K	X	X	X	-	-	-	-	-	-	-	-	-	
080-215	S01	F	-	-	-	X	X	X	X	-	-	-	X	-	
080-215	B01	F	X	X	X	-	-	-	-	-	-	-	-	-	
080-216	S01	F	-	-	-	X	X	X	X	-	-	-	X	-	
080-216	S02	E	-	-	-	X	X	X	X	-	-	-	X	-	
080-216	B01	F	X	X	X	-	-	-	-	-	-	-	-	-	
080-216	B02	E	X	X	X	-	-	-	-	-	-	-	-	-	
080-217	S01	F	-	-	-	X	X	X	X	-	-	-	X	-	
080-217	B01	F	X	X	X	-	-	-	-	-	-	-	-	-	
080-250	S01	K	-	-	-	X	X	X	X	-	-	-	X	-	
080-250	B01	K	X	X	X	-	-	-	-	-	-	-	-	-	
080-252	S01	F	-	-	-	X	X	X	X	-	-	-	X	-	
080-252	B01	F	X	X	X	-	-	-	-	-	-	-	-	-	
080-253	S02	F	-	-	-	X	X	X	X	-	-	-	X	-	
080-253	S02	E	-	-	-	X	X	X	X	-	-	-	X	-	
080-253	B02	F	X	X	X	-	-	-	-	-	-	-	-	-	
080-253	B02	E	X	X	X	-	-	-	-	-	-	-	-	-	
080-315	S05	D	-	-	-	X	X	X	X	X	-	-	-	-	
080-315	S03	D	-	-	-	X	X	X	X	-	-	-	X	-	
080-315	S03	F	-	-	-	-	-	-	-	-	-	-	-	-	
080-315	S03	K	-	-	-	X	X	X	X	-	-	-	X	-	
080-315	B03	D	X	X	X	-	-	-	-	-	-	-	-	-	
080-315	B03	F	-	-	-	-	-	-	-	-	-	-	-	-	
080-315	B03	K	X	X	X	-	-	-	-	-	-	-	-	-	
080-316	S03	D	-	-	-	X	X	X	X	-	-	-	X	-	
080-316	B03	D	X	X	X	-	-	-	-	-	-	-	-	-	
080-317	S03	F	-	-	-	X	X	X	X	-	-	-	X	-	
080-317	B03	F	X	X	X	-	-	-	-	-	-	-	-	-	
080-317	S03	D	-	-	-	X	X	X	X	-	-	-	X	-	
080-317	B03	D	X	X	X	-	-	-	-	-	-	-	-	-	
100-215	S01	F	-	-	-	X	X	X	X	-	-	-	X	-	
100-215	B01	F	X	X	X	-	-	-	-	-	-	-	-	-	
100-250	S01	E	-	-	-	X	X	X	X	-	-	-	X	-	
100-250	B01	E	-	-	-	-	-	-	-	-	-	-	-	-	
100-251	S02	F	-	-	-	X	X	X	X	-	-	-	X	-	
100-251	B02	E	-	-	-	-	-	-	-	-	-	-	-	-	
100-251	B02	F	X	X	X	-	-	-	-	-	-	-	-	-	
100-252	S01	F	-	-	-	X	X	X	X	-	-	-	X	-	
100-252	B01	F	X	X	X	-	-	-	-	-	-	-	-	-	
100-253	S02	F	-	-	-	X	X	X	X	-	-	-	X	-	
100-253	S02	E	-	-	-	X	X	X	X	-	-	-	X	-	
100-253	S02	D	-	-	-	X	X	X	X	-	-	-	X	-	
100-253	S02	K	-	-	-	X	X	X	X	-	-	-	X	-	









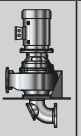
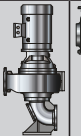

Size	Bearing bracket	Impeller type	Installation types												
			Sewabloc			Sewatec								Sewatec-vertical	
BLOC	BLOC-V	BLOC-VF	Fig. 0	3EN	3ENH	3HZ	3HM	3HVG-N	3HVG-NH	V	VU	VGW			
100-253	B02	F	X	X	X	-	-	-	-	-	-	-	-	-	
100-253	B02	K	X	X	X	-	-	-	-	-	-	-	-	-	
100-253	B02	D	X	X	X	-	-	-	-	-	-	-	-	-	
100-254	S01	F	-	-	-	X	X	X	X	-	-	-	X	-	
100-254	S01	K	-	-	-	X	X	X	X	-	-	-	X	-	
100-254	B01	F	X	X	X	-	-	-	-	-	-	-	-	-	
100-254	B01	K	X	X	X	-	-	-	-	-	-	-	-	-	
100-255	S02	E	-	-	-	-	-	-	-	-	-	-	-	-	
100-315	S05	D	-	-	-	X	X	X	X	-	-	-	X	-	
100-316	S03	D	-	-	-	X	X	X	X	-	-	-	X	-	
100-316	B03	D	X	X	X	-	-	-	-	-	-	-	-	-	
100-316	S03	K	-	-	-	X	X	X	X	-	-	-	X	-	
100-316	B03	K	X	X	X	-	-	-	-	-	-	-	-	-	
100-316	S03	F	-	-	-	X	X	X	X	-	-	-	X	-	
100-316	B03	F	X	X	X	-	-	-	-	-	-	-	-	-	
100-317	S03	E	-	-	-	X	X	X	X	-	-	-	X	-	
100-400	S05	K	-	-	-	X	X	X	X	X	-	-	X	X	
100-400	S04	K	-	-	-	X	X	X	X	-	-	-	-	-	
100-401	S05	E	-	-	-	X	X	X	X	X	-	-	X	X	
100-401	S05	F	-	-	-	X	X	X	X	X	-	-	X	X	
100-401	S05	K	-	-	-	X	X	X	X	X	-	-	X	X	
100-401	S04	E	-	-	-	X	X	X	X	-	-	-	-	-	
100-401	S04	F	-	-	-	X	X	X	X	-	-	-	-	-	
100-401	S04	K	-	-	-	X	X	X	X	-	-	-	-	-	
100-403	S04	D	-	-	-	X	X	X	X	-	-	-	-	-	
100-403	S05	D	-	-	-	X	X	X	X	X	-	-	X	X	
125-315	S03	F	-	-	-	-	-	-	-	-	-	-	-	-	
125-315	S03	K	-	-	-	-	-	-	-	-	-	-	-	-	
125-315	B03	F	-	-	-	-	-	-	-	-	-	-	-	-	
125-315	B03	K	-	-	-	-	-	-	-	-	-	-	-	-	
125-317	S03	E	-	-	-	-	-	-	-	-	-	-	-	-	
125-317	B03	E	-	-	-	-	-	-	-	-	-	-	-	-	
150-253	S02	D	-	-	-	X	X	X	X	-	-	-	X	-	
150-253	B02	D	X	X	X	-	-	-	-	-	-	-	-	-	
150-315	S03	D	-	-	-	X	X	X	X	-	-	-	X	-	
150-315	S03	F	-	-	-	X	X	X	X	-	-	-	X	-	
150-315	S03	K	-	-	-	-	-	-	-	-	-	-	-	-	
150-315	B03	D	X	X	X	-	-	-	-	-	-	-	-	-	
150-315	B03	E	-	-	-	-	-	-	-	-	-	-	-	-	
150-315	B03	F	X	X	X	-	-	-	-	-	-	-	-	-	
150-315	B03	K	-	-	-	-	-	-	-	-	-	-	-	-	
150-317	S05	K	-	-	-	X	X	X	-	-	-	-	-	-	
150-317	S03	E	-	-	-	X	X	X	X	-	-	-	X	-	
150-317	S03	K	-	-	-	X	X	X	X	-	-	-	X	-	
150-317	B03	K	X	X	X	-	-	-	-	-	-	-	-	-	
150-317	S03	D	-	-	-	X	X	X	X	-	-	-	X	-	
150-317 <sup>44)</sup>	B03	D	X	X	X	-	-	-	-	-	-	-	-	-	
150-400	S05	K	-	-	-	X	X	X	X	X	-	-	X	X	
150-400	S05	D	-	-	-	X	X	X	X	X	-	-	X	X	
150-400	S04	K	-	-	-	X	X	X	X	-	-	-	-	-	
150-401	S05	D	-	-	-	X	X	X	X	X	-	-	X	X	
150-401	S05	E	-	-	-	X	X	X	X	X	-	-	X	X	
150-401	S05	F	-	-	-	X	X	X	X	X	-	-	X	X	
150-401	S05	K	-	-	-	-	-	-	-	-	-	-	-	-	
150-401	S04	E	-	-	-	X	X	X	X	-	-	-	-	-	
150-401	S04	F	-	-	-	X	X	X	X	-	-	-	-	-	
150-401	S04	K	-	-	-	-	-	-	-	-	-	-	-	-	
150-401	S06	E	-	-	-	X	X	X	-	X	-	-	X	X	
150-401	S06	D	-	-	-	X	X	X	-	-	-	-	X	X	

44 Consult the manufacturer.

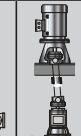

Size	Bearing bracket	Impeller type	Installation types											
			Sewabloc			Sewatec						Sewatec-vertical		
BLOC	BLOC-V	BLOC-VF	Fig. 0	3EN	3ENH	3HZ	3HM	3HVG-N	3HVG-NH	V	VU	VGW		
150-403	S04	K	-	-	-	X	X	X	X	-	-	-	-	-
150-403	S05	K	-	-	-	X	X	X	X	X	-	-	X	X
150-403	S04	D	-	-	-	X	X	X	X	-	-	-	-	-
150-403	S05	D	-	-	-	X	X	X	X	X	-	-	X	X
150-503	S06	K	-	-	-	X	X	X	-	X	-	-	X	X
150-503	S07	K	-	-	-	X	X	X	-	X	X	-	X	X
150-503 <sup>44)</sup>	S06	D	-	-	-	X	X	X	-	X	-	-	X	X
150-503 <sup>44)</sup>	S07	D	-	-	-	X	X	X	-	X	X	-	X	X
151-401	S05	K	-	-	-	-	-	-	-	-	-	-	-	-
151-403	S04	K	-	-	-	X	X	X	X	-	-	-	-	-
151-403	S05	K	-	-	-	X	X	X	X	X	-	-	X	X
200-315	S03	D	-	-	-	X	X	X	X	-	-	-	X	-
200-315	S03	K	-	-	-	X	X	X	X	-	-	-	X	-
200-315	B03	D	X	X	X	-	-	-	-	-	-	-	-	-
200-315	B03	K	X	X	X	-	-	-	-	-	-	-	-	-
200-316	S03	K	-	-	-	X	X	X	X	-	-	-	X	-
200-316	B03	K	X	X	X	-	-	-	-	-	-	-	-	-
200-317	S05	K	-	-	-	X	X	X	-	-	-	-	-	-
200-317	S03	K	-	-	-	X	X	X	X	-	-	-	X	-
200-317	B03	K	X	X	X	-	-	-	-	-	-	-	-	-
200-318	S03	K	-	-	-	X	X	X	X	-	-	-	X	-
200-318	B03	K	X	X	X	-	-	-	-	-	-	-	-	-
200-330	S05	K	-	-	-	-	-	-	-	-	-	-	-	-
200-330	S04	K	-	-	-	-	-	-	-	-	-	-	-	-
200-400	S05	D	-	-	-	X	X	X	X	X	-	-	X	X
200-400	S06	D	-	-	-	X	X	X	-	X	-	-	X	X
200-401	S05	E	-	-	-	X	X	X	X	X	-	-	X	X
200-401	S05	K	-	-	-	-	-	-	-	-	-	-	-	-
200-401	S04	E	-	-	-	X	X	X	X	-	-	-	-	-
200-401	S04	K	-	-	-	-	-	-	-	-	-	-	-	-
200-401	S06	E	-	-	-	X	X	X	-	X	-	-	X	X
200-402	S05	K	-	-	-	X	X	X	X	X	-	-	X	X
200-402	S04	K	-	-	-	X	X	X	X	-	-	-	-	-
200-402	S06	K	-	-	-	X	X	X	-	X	-	-	X	X
200-402	S05	D	-	-	-	X	X	X	X	X	-	-	X	X
200-402	S04	D	-	-	-	X	X	X	X	-	-	-	-	-
200-402	S06	D	-	-	-	X	X	X	-	X	-	-	X	X
200-403	S04	K	-	-	-	X	X	X	X	-	-	-	-	-
200-403	S05	K	-	-	-	X	X	X	X	X	-	-	X	X
200-403	S06	K	-	-	-	X	X	X	-	X	-	-	X	X
200-405	S04	D	-	-	-	X	X	X	X	-	-	-	-	-
200-405	S05	D	-	-	-	X	X	X	X	X	-	-	X	X
200-405	S06	D	-	-	-	X	X	X	-	X	-	-	X	X
200-500	S05	E	-	-	-	X	X	X	-	X	-	-	X	X
200-501	S06	K	-	-	-	-	-	-	-	-	-	-	-	-
200-502	S06	K	-	-	-	X	X	X	-	X	-	-	X	X
200-502	S07	K	-	-	-	X	X	X	-	X	X	-	X	X
200-503	S06	K	-	-	-	X	X	X	-	X	-	-	X	X
200-503	S07	K	-	-	-	X	X	X	-	X	X	-	X	X
200-503 <sup>44)</sup>	S06	D	-	-	-	X	X	X	-	X	-	-	X	X
200-503 <sup>44)</sup>	S07	D	-	-	-	X	X	X	-	X	X	-	X	X
200-631	S07	K	-	-	-	-	-	-	-	-	-	-	-	-
200-631	S08	K	-	-	-	-	-	-	-	-	-	-	-	-
250-400	S05	D	-	-	-	X	X	X	X	X	-	-	X	X
250-400	S05	K	-	-	-	-	-	-	-	-	-	-	-	-
250-400	S04	K	-	-	-	-	-	-	-	-	-	-	-	-
250-400	S06	D	-	-	-	X	X	X	-	X	-	-	X	X
250-401	S05	K	-	-	-	X	X	X	X	X	-	-	X	X
250-401	S04	K	-	-	-	X	X	X	X	-	-	-	-	-
250-401	S06	K	-	-	-	X	X	X	-	X	-	-	X	X
250-402	S04	D	-	-	-	X	X	X	X	-	-	-	-	-

Size	Bearing bracket	Impeller type	Installation types													
			Sewabloc			Sewabloc-vertical			Sewatec					Sewatec-vertical		
			BLOC	BLOC-V	BLOC-VF	Fig. 0	3EN	3ENH	3HZ	3HM	3HVG-N	3HVG-NH	V	VU	VGW	
250-402	S05	D	-	-	-	X	X	X	X	X	-	-	X	X	X	
250-402	S06	D	-	-	-	X	-	-	-	X	-	-	X	X	X	
250-403	S04	K	-	-	-	X	X	X	X	-	-	-	-	-	-	
250-403	S05	K	-	-	-	X	X	X	X	X	-	-	X	X	X	
250-403	S06	K	-	-	-	X	-	-	-	-	-	-	X	X	X	
250-500	S06	E	-	-	-	X	X	X	-	X	-	-	X	X	X	
250-500	S07	E	-	-	-	X	X	X	-	X	-	-	X	X	X	
250-630	S07	K	-	-	-	-	-	-	-	-	-	-	-	-	-	
250-630	S07	E	-	-	-	X	X	X	-	X	-	-	X	X	X	
250-630	S08	E	-	-	-	X	X	X	-	-	X	X	X	X	X	
250-630	S08	K	-	-	-	-	-	-	-	-	-	-	-	-	-	
250-632	S07	K	-	-	-	X	X	X	-	X	X	X	X	X	X	
250-632	S08	K	-	-	-	X	X	X	-	-	X	X	X	X	X	
250-900	S09	K	-	-	-	-	-	-	-	-	-	-	X	-	-	
300-400	S05	D	-	-	-	X	X	X	X	X	-	-	X	X	X	
300-400	S05	K	-	-	-	X	X	X	X	X	-	-	X	X	X	
300-400	S04	K	-	-	-	X	X	X	X	-	-	-	-	-	-	
300-400	S06	D	-	-	-	X	X	X	-	X	-	-	X	X	X	
300-401	S05	K	-	-	-	X	X	X	X	X	-	-	X	X	X	
300-401	S04	K	-	-	-	X	X	X	X	-	-	-	-	-	-	
300-402	S05	D	-	-	-	X	X	X	X	X	-	-	X	X	X	
300-402	S06	D	-	-	-	X	X	X	-	X	-	-	X	X	X	
300-402	S04	D	-	-	-	X	X	X	X	-	-	-	-	-	-	
300-403	S05	K	-	-	-	X	X	X	X	X	-	-	X	X	X	
300-500	S06	K	-	-	-	X	X	X	-	X	-	-	X	X	X	
300-500	S07	K	-	-	-	X	X	X	-	-	X	X	X	X	X	
300-502 <sup>44)</sup>	S06	D	-	-	-	X	X	X	-	X	-	-	X	X	X	
300-502 <sup>44)</sup>	S07	D	-	-	-	X	X	X	-	X	X	X	X	X	X	
300-505	S06	K	-	-	-	X	X	X	-	X	-	-	X	X	X	
300-505	S07	K	-	-	-	X	X	X	-	X	X	X	X	X	X	
300-505 <sup>44)</sup>	S06	D	-	-	-	X	X	X	-	X	-	-	X	X	X	
300-505 <sup>44)</sup>	S07	D	-	-	-	X	X	X	-	X	X	X	X	X	X	
300-630	S07	E	-	-	-	X	X	X	-	X	-	-	X	X	X	
300-630	S08	E	-	-	-	X	X	X	-	-	X	X	X	X	X	
350-500	S07	K	-	-	-	X	X	X	-	X	X	X	X	X	X	
350-500	S06	K	-	-	-	X	X	X	-	X	-	-	X	X	X	
350-501	S06	K	-	-	-	-	-	-	-	-	-	-	-	-	-	
350-501	S07	K	-	-	-	-	-	-	-	-	-	-	-	-	-	
350-502 <sup>44)</sup>	S06	D	-	-	-	X	X	X	-	X	-	-	X	X	X	
350-502 <sup>44)</sup>	S07	D	-	-	-	X	X	X	-	X	X	X	X	X	X	
350-503	S06	K	-	-	-	X	X	X	-	X	-	-	X	X	X	
350-503	S07	K	-	-	-	X	X	X	-	X	X	X	X	X	X	
350-503 <sup>44)</sup>	S06	D	-	-	-	X	X	X	-	X	-	-	X	X	X	
350-503 <sup>44)</sup>	S07	D	-	-	-	X	X	X	-	X	X	X	X	X	X	
350-632	S07	K	-	-	-	X	X	X	-	X	X	X	X	X	X	
350-632	S08	K	-	-	-	X	X	X	-	-	X	X	X	X	X	
350-633	S07	K	-	-	-	X	X	X	-	X	X	X	X	X	X	
350-633	S08	K	-	-	-	X	X	X	-	-	X	X	X	X	X	
350-710	S08	E	-	-	-	X	X	X	-	-	X	X	X	X	X	
350-710	S07	E	-	-	-	X	-	-	-	-	-	-	X	X	X	
350-710	S08	K	-	-	-	X	X	X	-	-	-	-	X	X	X	
350-713	S08	K	-	-	-	X	X	X	-	-	X	X	X	X	X	
350-713	S09	K	-	-	-	-	-	-	-	-	-	-	X	X	X	
400-500	S06	K	-	-	-	X	-	-	-	-	-	-	X	X	X	
400-500	S07	K	-	-	-	X	-	-	-	-	-	-	X	X	X	
400-632	S08	K	-	-	-	X	X	X	-	-	X	X	X	X	X	
400-710	S09	K	-	-	-	-	-	-	-	-	-	-	X	-	-	
400-713	S09	K	-	-	-	-	-	-	-	-	-	-	X	-	-	
400-900	S09	K	-	-	-	-	-	-	-	-	-	-	X	-	-	
500-632	S08	K	-	-	-	-	-	-	-	-	-	-	-	-	-	

Size	Bearing bracket	Impeller type	Installation types										Sewatec-vertical		
			Sewabloc			Sewabloc-vertical			Sewatec				Sewatec-vertical		
															
BLOC	BLOC-V	BLOC-VF	Fig. 0	3EN	3ENH	3HZ	3HM	3HVG-N	3HVG-NH	V	VU	VGW			
500-634	S07	K	-	-	-	X	X	X	-	-	X	X	X	X	X
500-634	S08	K	-	-	-	X	X	X	-	-	X	X	X	X	X
500-710	S09	K	-	-	-	-	-	-	-	-	-	-	X	-	-
500-900	S09	K	-	-	-	-	-	-	-	-	-	-	X	-	-
500-900	S10	K	-	-	-	-	-	-	-	-	-	-	X	-	-
600-520	S07	K	-	-	-	X	-	-	-	-	-	-	X	X	X
600-710	S08	K	-	-	-	X	-	-	-	-	-	-	X	-	X
600-900	S10	K	-	-	-	-	-	-	-	-	-	-	X	-	-
700-902	S08	K	-	-	-	X	-	-	-	-	-	-	X	X	X
700-902	S09	K	-	-	-	-	-	-	-	-	-	-	X	-	-

### Recommended spare parts stock for 2 years' operation to DIN 24296

Table 28: Quantity of spare parts for recommended spare parts stock

Part No.	Description	Number of pumps (including stand-by pumps)								Spare part	Replacement part	Wear part
		1	2	3	4	5	6	8	10 and more			
135	Wear plate	1	2	2	2	3	3	4	50 %	-	-	✗
163	Discharge cover	1	2	2	2	3	3	4	50 %	✗	-	-
210	Shaft	1	1	1	2	2	2	3	30 %	✗	-	-
230	Impeller	1	1	1	2	2	2	3	30 %	-	✗	-
321.01/02	Rolling element bearing (set)	1	1	1	2	2	3	4	50 %	-	-	✗
330	Bearing bracket, complete	-	-	-	-	-	-	1	2 pcs.	✗	-	-
433.01/02	Mechanical seal, complete (set)	1	2	3	4	4	4	6	90 %	-	-	✗
502.01	Casing wear ring	1	2	2	2	3	3	4	50 %	-	-	✗
503	Impeller wear ring	1	2	2	2	3	3	4	50 %	-	-	✗
	Assembly for gland packing consisting of: ▪ Neck bush ▪ Shaft protecting sleeve ▪ Lantern ring	1	1	1	2	2	2	3	40 %	-	✗	-
	Packing cord (4 rings)	4	4	6	8	8	9	12	100 %	-	-	✗
	Sealing elements (set)	2	4	6	8	8	9	12	150 %	-	-	✗

Keeping a stock of wear parts and replacement parts is recommended also during the warranty period.

#### Scope of supply

##### Sewabloc

Depending on the model, the following items are included in the scope of supply:

- Pump without motor or with directly flanged standardised motor
- Foundation rails (for horizontal installation)
- Suction-side flanged spacer or suction elbow with inspection hole
- Baseplate or soleplate
- Duckfoot bend (for vertical installation)

##### Sewatec

Depending on the model, the following items are included in the scope of supply:

- Pump
- Drive
- Baseplate or soleplate
- Coupling
- Coupling guard
- Suction-side flanged spacer or suction elbow with inspection hole
- Universal-joint shaft
- Foundation rails (for horizontal installation)

General arrangement drawings with list of components

General assembly drawing – Sewatec with bearing brackets S01, S02, S03, S04

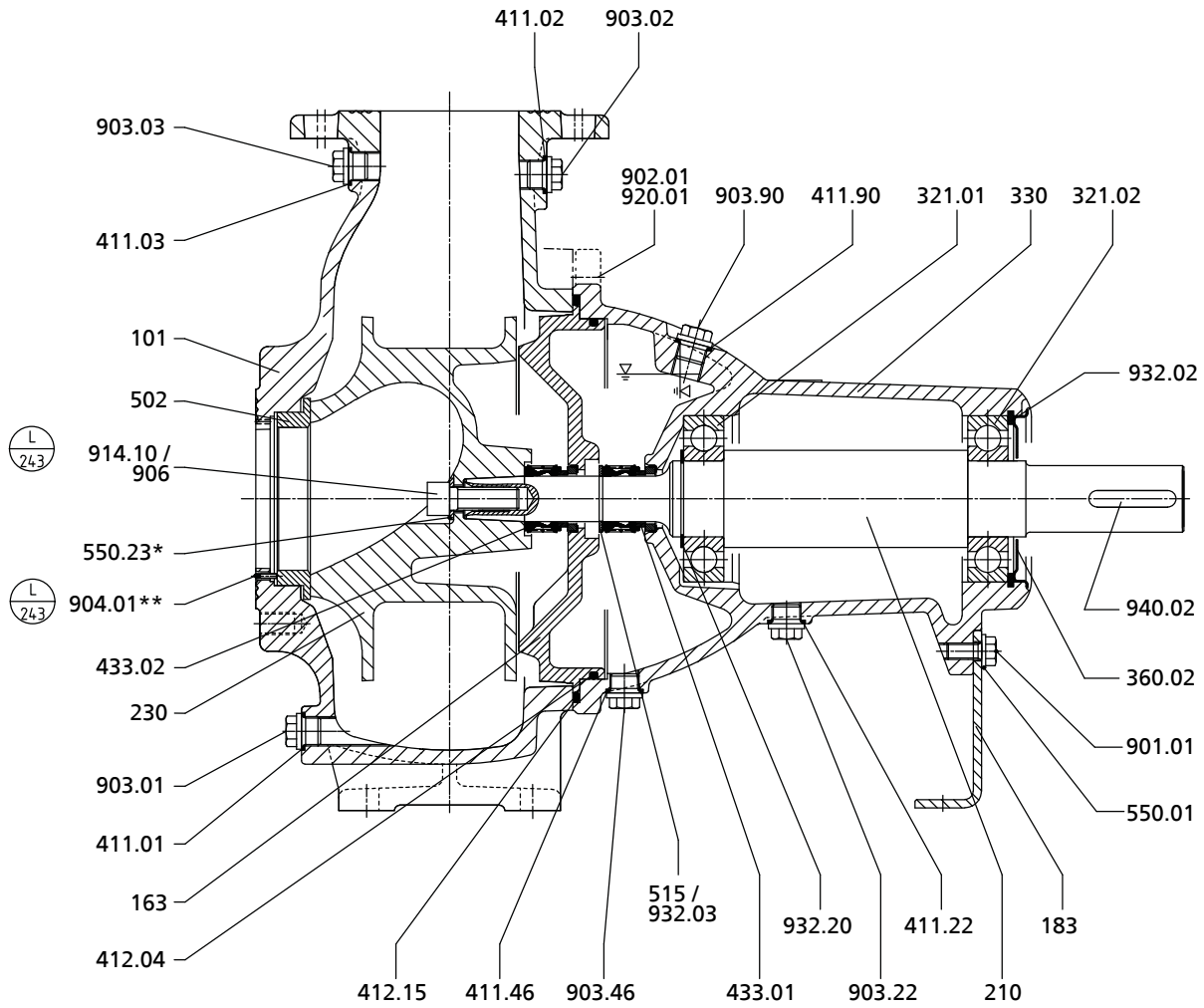

Fig. 1: General assembly drawing of Sewatec - with bearing brackets S01, S02, S03, S04, impeller type E; \* if any, \*\* only for sizes E 100-250, E 100-253, E 100-317, E 150-317, K 100-253, K 100-254, K 100-316

Table 29: List of components

Part No.	Description	Part No.	Description
101	Pump casing	502	Casing wear ring
135	Wear plate	515	Locking ring
163	Discharge cover	550.01/.04/.23	Disc
164.02	Inspection cover	900.02	Bolt/screw
183	Support foot	901.01	Hexagon head bolt
210	Shaft	902.01	Stud
230	Impeller	903.01/.02/.03/.22/.46/.90	Screw plug
321.01/.02	Radial ball bearing	904.01	Grub screw
330	Bearing bracket	906	Impeller screw
360.02	Bearing cover	914.10/.12/.24	Hexagon socket head cap screw
411.01/.02/.03/.22/.46/.90	Joint ring	920.01/.17	Nut
412.04/.05/.15/.34	O-ring	932.02/.03/.20	Circlip
433.01/.02	Mechanical seal		

General assembly drawing – Sewatec with bearing brackets S05, S06, S07, S08

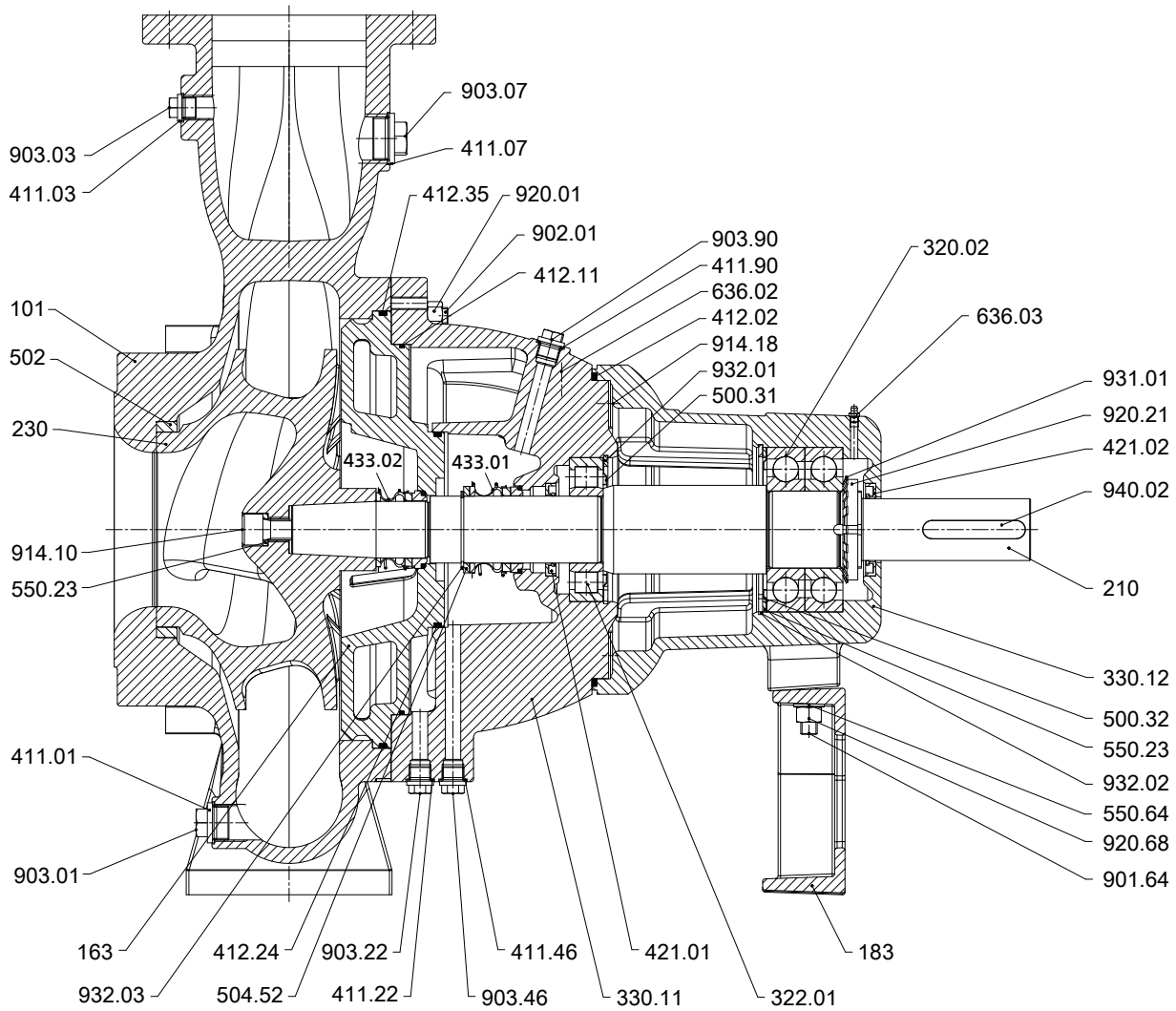

Fig. 2: Sewatec with bearing brackets S05 to S08

Table 30: List of components

Part No.	Description	Part No.	Description
101	Pump casing	502	Casing wear ring
163	Discharge cover	504.52	Spacer ring
183	Support foot	550.23/.64	Disc
210	Shaft	636.02/.03	Lubricating nipple
230	Impeller	901.64	Hexagon head bolt
320.02	Rolling element bearings	902.01	Stud
322.01	Radial roller bearing	903.01/.03/.07/.22/.46/.90	Screw plug
330.11/.12	Bearing bracket	914.10/.18	Hexagon socket head cap screw
411.01/.03/.07/.22/.46/.90	Joint ring	920.01/.21/.68	Nut
412.02/.11/.24/.35	O-ring	931.01	Lock washer
421.01/.02	Lip seal	932.01/.02/.03	Circlip
433.01/.02	Mechanical seal	940.02	Key
500.31/.32	Ring		

General assembly drawing: Sewatec with bearing brackets S05, S06, S07, underfloor installation and installation with universal-joint shaft

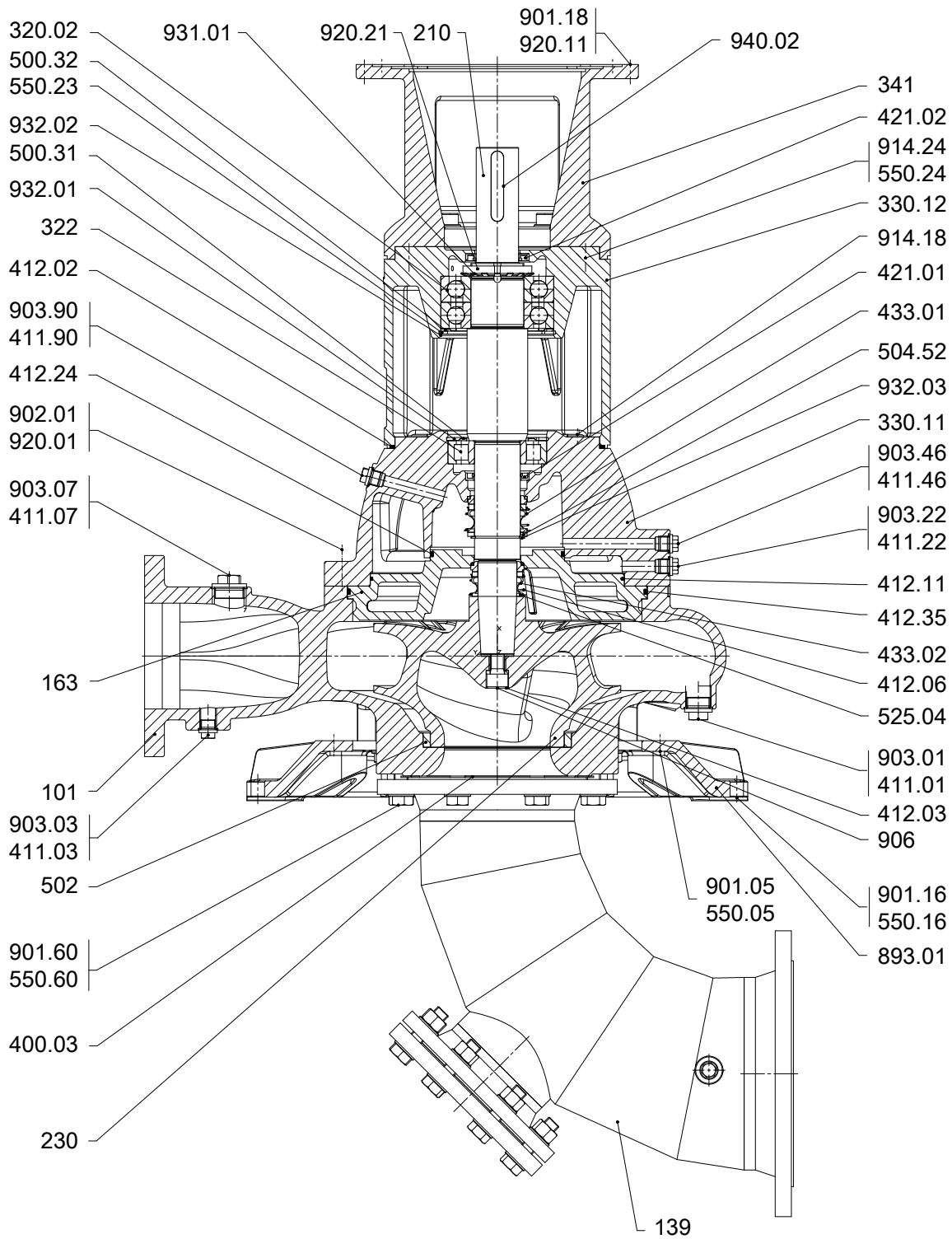

Fig. 3: Sewatec with E impeller – pump for underfloor installation and installation with universal-joint shaft

**Table 31:** List of components

Part No.	Description	Part No.	Description
101	Pump casing	502	Casing wear ring
139	Suction elbow	504.52	Spacer ring
163	Discharge cover	525.04	Spacer sleeve
210	Shaft	550.05/.16/.23/.24/.60	Disc
230	Impeller	893.01 <sup>45)</sup>	Soleplate
320.02	Rolling element bearing	901.05 <sup>45)</sup> /.16/.18/.60	Hexagon head bolt
322	Radial roller bearing	902.01	Stud
330.11/.12	Bearing bracket	903.01/.03/.07/.22/.46/.90	Screw plug
341 <sup>46)</sup>	Drive lantern	906	Impeller screw
400.03	Gasket	914.18./24 <sup>46)</sup>	Hexagon socket head cap screw
411.01/.03/.07/.22/.46/.90	Joint ring	920.01/.11/.21	Nut
412.02/.03 <sup>47)</sup> /.06/.11/.24/.35	O-ring	931.01	Lock washer
421.01/.02	Lip seal	932.01/.02/.03	Circlip
433.01/.02	Mechanical seal	940.02	Key
500.31/.32	Ring		

<sup>45</sup> Only for Sewatec K 100-400, F/K 100-401, D 100-403, D/K 150-400, D 150-401, D/K 150-403, K 150-503, K 151-403, D 200-400, D/K 200-402, K 200-403, D 200-405, K 200-502, K 200-503, D 250-402, D 300-402

<sup>46</sup> Not for universal-joint shaft

<sup>47</sup> For S05 only



General assembly drawing – Sewatec with bearing brackets S09, S10

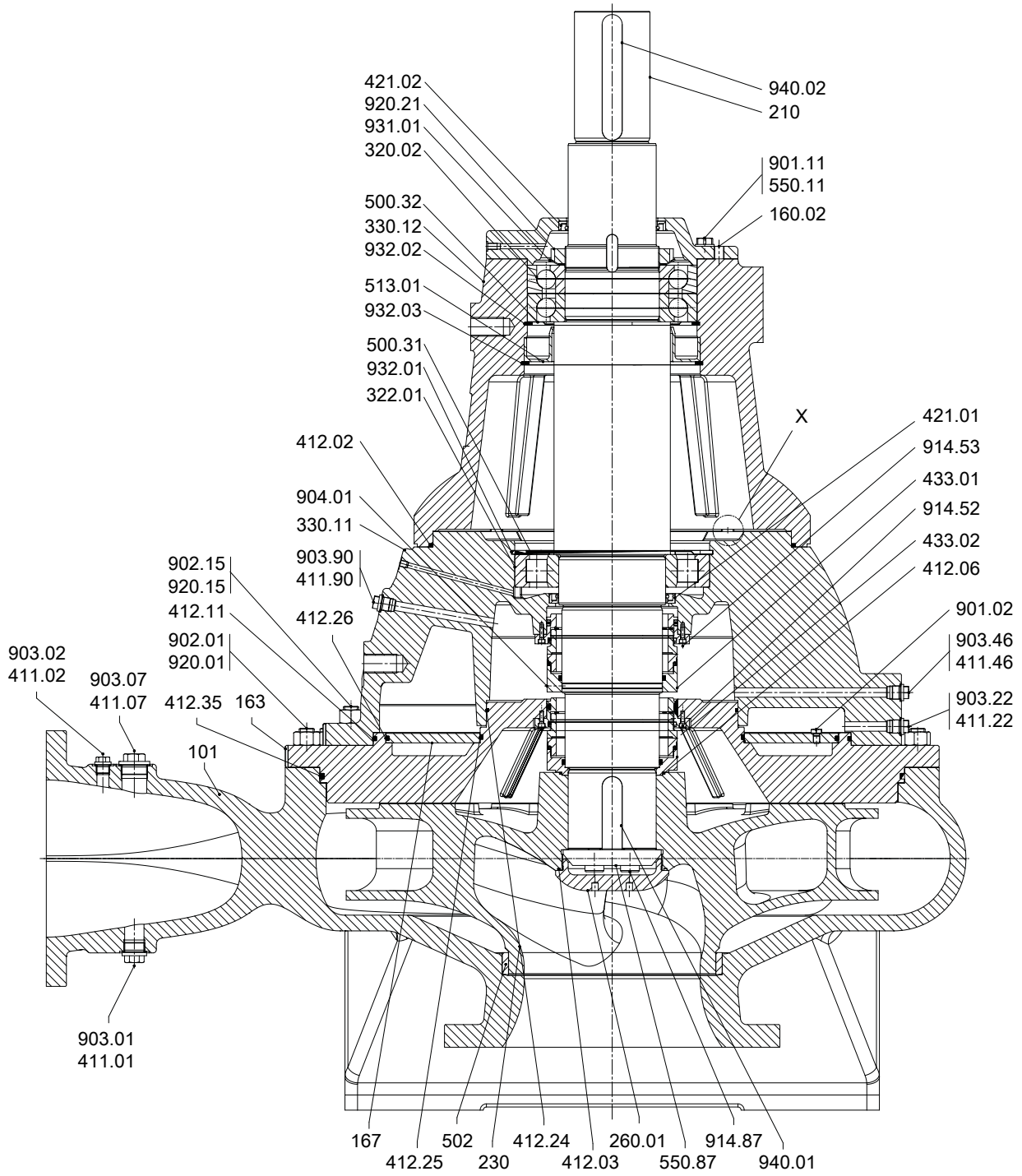

Fig. 4: Sewatec with bearing brackets S09, S10

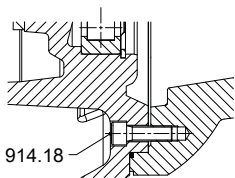

Fig. 5: Detail X

2580.5/28-EN

**Table 32:** List of components

Part No.	Description	Part No.	Description
101	Pump casing	500.31/.32	Ring
160.02	Cover	502	Casing wear ring
163	Discharge cover	513.01	Insert ring
167	Cover insert	550.04/.11/.87	Disc
210	Shaft	901.02/.11	Hexagon head bolt
230	Impeller	902.01/.02/.15	Stud
260.01	Impeller hub cap	903.01/.02/.07/.22/.46/.90	Screw plug
320.02	Rolling element bearings	904.01	Grub screw
322.01	Radial roller bearing	914.18/.52/.53/.87	Hexagon socket head cap screw
330.11/.12	Bearing bracket	920.01/.15/.17/.21	Nut
411.01/.02/.07/.22/.46/.90	Joint ring	931.01	Lock washer
412.02/.03/.05/.06/.11/.24/.25/.26/.35	O-ring	932.01/.02/.03	Circlip
421.01/.02	Lip seal	940.01/.02	Key
433.01/.02	Mechanical seal		

General assembly drawing – Sewabloc

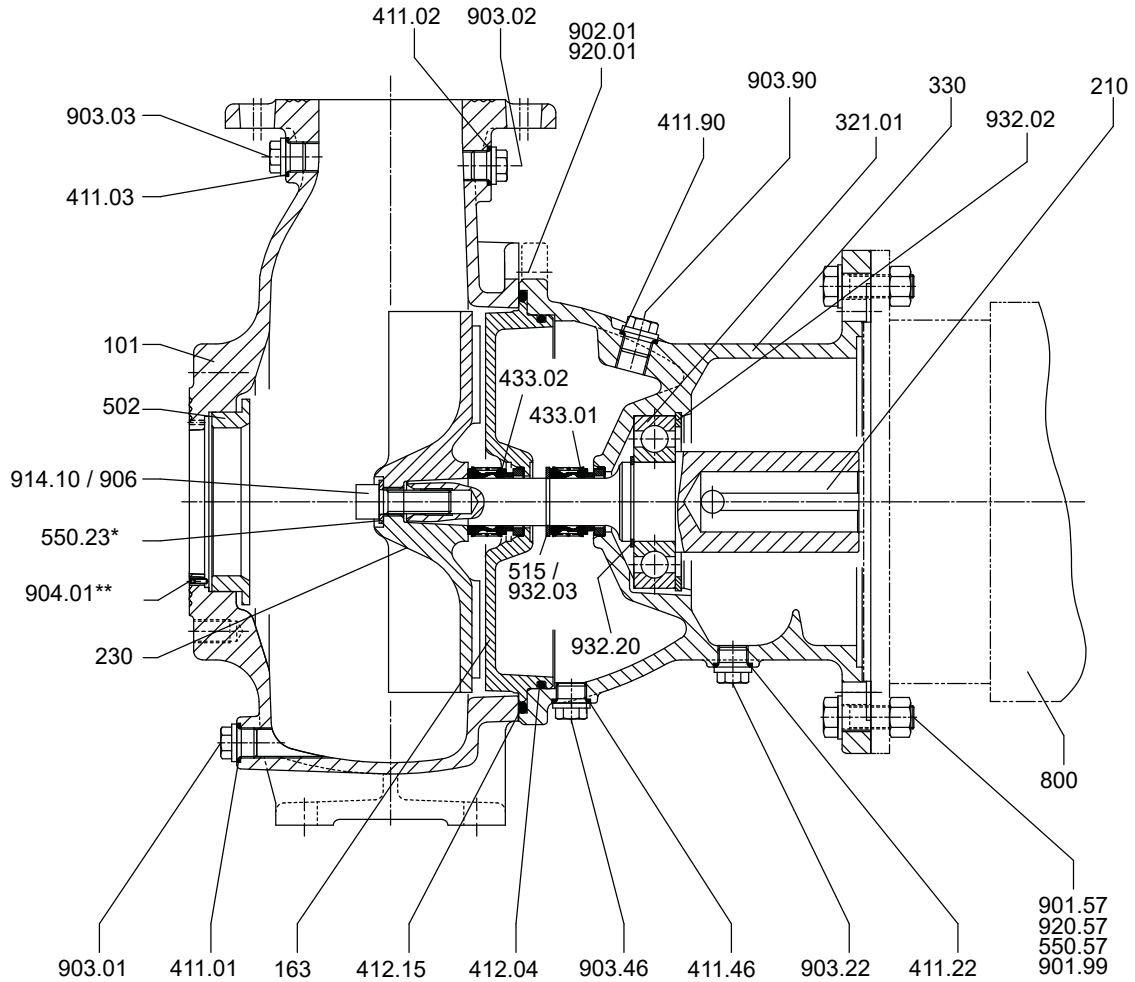

Fig. 6: General assembly drawing of Sewabloc; \* if any, \*\* only for sizes 100-253, 100-254, K 100-316

Table 33: List of components

Part No.	Description	Part No.	Description
101	Pump casing	502	Casing wear ring
135	Wear plate	550.23/.57	Disc
163	Discharge cover	800	Motor
164	Inspection cover	901.57/.99	Hexagon head bolt
210	Shaft	902.01	Stud
230	Impeller	903.01/.02/.03/.22/.46/.90	Screw plug
321.01	Radial ball bearing	904.01	Grub screw
330	Bearing bracket	906	Impeller screw
411.01/.02/.03/.22/.46/.90	Joint ring	914.10/.12/.24	Hexagon socket head cap screw
412.04/.15/.34	O-ring	920.01/.57	Nut
433.01/.02	Mechanical seal	932.02	Circlip

Detail drawings

Impeller types

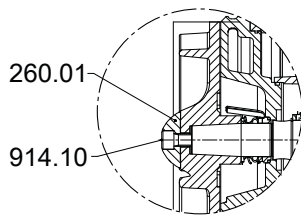

Fig. 7: F impeller

Table 34: List of components

Part No.	Description	Part No.	Description
260.01	Impeller hub cap	914.10	Hexagon socket head cap screw

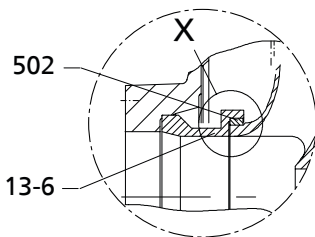

Fig. 8: K impeller

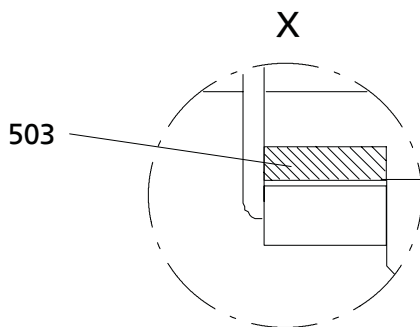

Fig. 9: Detail X: impeller wear ring for K impeller

Table 35: List of components

Part No.	Description	Part No.	Description
13-6 <sup>48)</sup>	Casing insert	502 <sup>49)</sup>	Casing wear ring
503	Impeller wear ring		

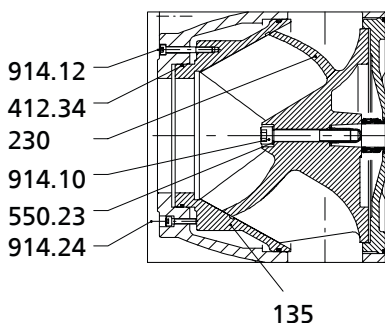

Fig. 10: D impeller (single-vane impeller) and D impeller (multi-vane impeller)

Table 36: List of components

Part No.	Description	Part No.	Description
230	Impeller	550.23	Disc
412.34	O-ring	914.10/.12/.24	Hexagon socket head cap screw

Impeller fastening

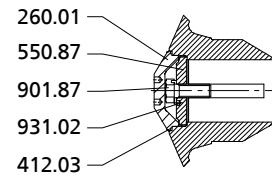

Fig. 11: Impeller fastening for bearing brackets S06, S07 and S08, except Sewatec size 500-632

Table 37: List of components

Part No.	Description	Part No.	Description
260.01	Impeller hub cap	901.87	Hexagon head bolt
412.03	O-ring	931.02	Lock washer
550.87	Disc		

Inspection hole, bearing brackets S01 to S08

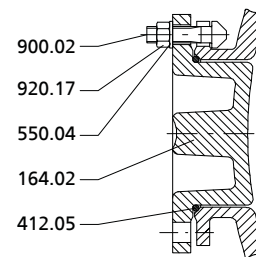

Fig. 12: Inspection hole, bearing brackets S01 to S08

Table 38: List of components

Part No.	Description	Part No.	Description
164.02	Inspection cover	900.02	Screw
412.05	O-ring	920.17	Nut
550.04	Disc		

Inspection hole, bearing brackets S09 and S10

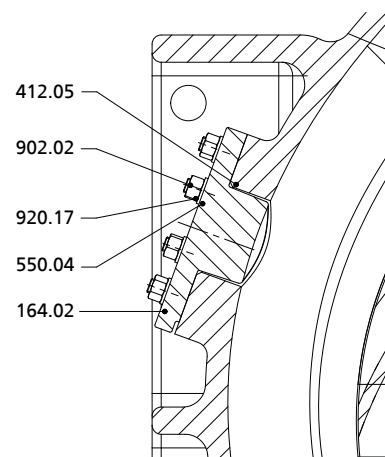

Fig. 13: Inspection hole, bearing brackets S09 and S10

<sup>48</sup> Only for Sewatec 100-401 and 200-400

<sup>49</sup> Not for Sewatec 100-401

Table 39: List of components

Part No.	Description	Part No.	Description
164.02	Inspection cover	902.17	Stud
412.05	O-ring	920.17	Nut
550.04	Disc		

Drilled hole required during manufacturing, bearing brackets S09 and S10

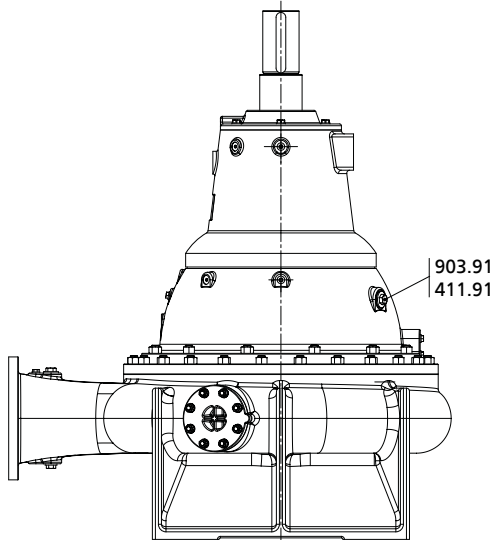

Fig. 14: Drilled hole required during manufacturing, bearing brackets S09 and S10

Table 40: List of components

Part No.	Description	Part No.	Description
411.91	Joint ring	903.91	Screw plug







**KSB SE & Co. KGaA**  
Turmstraße 92 • 06110 Halle (Germany)  
Tel. +49 345 4826-0  
[www.ksb.com](http://www.ksb.com)