

Circulator / High-efficiency Drinking Water Pump

CalioTherm Pro

Also applies to Calio-Therm

Type Series Booklet



Legal information/Copyright

Type Series Booklet CalioTherm Pro

All rights reserved. The contents provided herein must neither be distributed, copied, reproduced, edited or processed for any other purpose, nor otherwise transmitted, published or made available to a third party without the manufacturer's express written consent.

Subject to technical modification without prior notice.

© KSB SE & Co. KGaA, Frankenthal 2023-01-24

Contents

Building Services: Heating	4
Drinking Water Circulators, Fixed Speed Version	4
CalioTherm Pro.....	4
Main applications.....	4
Fluids handled	4
Operating data.....	4
Design details	4
Designation	5
Materials.....	5
Product benefits.....	6
Product information	6
Selection information	7
Technical data	9
Selection chart.....	9
Characteristic curves.....	10
Dimensions	13
Installation information.....	14
Scope of supply	14
Accessories.....	14

Building Services: Heating

Drinking Water Circulators, Fixed Speed Version

CalioTherm Pro

i Also applies to Calio-Therm



Main applications

- Drinking water circulation systems to DVGW-W551

Fluids handled

- Drinking water and water for the food and beverage industry, as per German TrinkwV 2001 drinking water regulations

Operating data

Table 1: Operating properties

Characteristic	Value	
Flow rate	Q [m ³ /h]	≤ 24
	Q [l/s]	≤ 6,7
Head	H [m]	≤ 12
Fluid temperature ¹⁾	T [°C]	≥ +2
		≤ +70 ²⁾
Hardness of fluid handled	[°dH]	≤ 20
	[°fH]	≤ 35,7
Ambient temperature	T [°C]	≥ 0
		≤ +40
Operating pressure	p [bar]	≤ 10
Pressure class	PN [bar]	6/10
Average sound pressure level	[dB (A)]	≤ 40
Screw-ended connection	G	1 1/2 - 2
Flanged connection	DN	40

¹ We recommend fluid temperatures no higher than 65 °C to prevent possible consequences caused by lime sedimentation. Higher fluid temperatures are permissible for short periods (e.g. for thermal disinfection cycles).

² ≤ +75 °C for short-time operation ≤ 5 minutes

Design details

Design

- Maintenance-free high-efficiency wet rotor pump (glandless)

Drive

- High-efficiency permanent magnet synchronous motor, brushless, self-cooling, with continuously variable differential pressure control
- Integrated motor protection
- 1~230 V AC +/- 10%
- Frequency 50 Hz/60 Hz
- Enclosure IPX4D
- Thermal class F
- Temperature class TF 110
- Interference emissions EN 55014-1, EN 61000-3-2, EN 61000-3-3
- Interference immunity EN 55014-2

Bearings

- Product-lubricated special plain bearing

Connections

- Screw-ended or flanged

Operating modes

- Constant-pressure control
- Proportional-pressure control
- Temperature-governed differential pressure control (can only be activated with KSB ServiceTool)
- Open-loop control via setpoint setting
- Eco Mode

Automatic functions

- Continuously variable speed adjustment depending on the mode of operation
- 0 - 10 V with external differential pressure/speed setpoint
- 0 - 10 V as input of the actual value of the temperature or actual value of the differential pressure
- Dual-pump operation
- Peak load operation
- Setback operation
- Dynamic Control
- Remote ON/OFF
- Deblocking function
- Self-venting function
- Soft start
- Full motor protection with integrated trip electronics

Manual functions

- Setting the operating mode
- Setting the discharge head setpoint
- Setting the speed level
- Locking the control panel

Signalling functions and display functions

- Periodically alternating display of flow rate, head and electrical input power
- Operating status shown on the display
- Error codes indicated on the display
- Configurable general fault message and "in operation" message (volt-free changeover contacts)
- Serial digital Modbus RTU interface
- Service interface for KSB ServiceTool

Designation

Example: CalioTherm Pro 25-80

Table 2: Designation key

Code	Description	
CalioTherm Pro	Type series	
25	Nominal diameter of pump nozzle	
	25	G 1 1/2
	30	G 2
	40	DN 40
80	Head H ³⁾ [m]	
	80	Head × 10 Example: 8 m × 10 = 80

Example: Calio-Therm 25-80

Table 3: Designation key

Code	Description	
Calio-Therm	Type series	
25	Nominal diameter of pump nozzle	
	25	G 1 1/2
	30	G 2
	40	DN 40
80	Head H ⁴⁾ [m]	
	80	Head × 10 Example: 8 m × 10 = 80

Materials

Table 4: Overview of available materials

Part No.	Description	Material
102	Volute casing	Stainless steel 1.4308
210	Shaft	Stainless steel 1.4034
230	Impeller	Plastic with glass fibre content (PSU-GF30)
310	Bearing	Ceramics/carbon
689	Thermal insulation shells	Polypropylene
817	Can	Plastic with glass fibre content (PPS-GF40)

Casing parts which are in contact with the atmosphere and with the fluid handled are free from paint-wetting impairment materials.

All wetted components are DVGW-approved for use in drinking water circulation systems.

³ At flow rate Q = 0 m³/h

⁴ At flow rate Q = 0 m³/h

Product benefits

- High-efficiency technology combined with speed control and efficient operation by means of **Dynamic Control** offer maximum savings.
- All-in concept saves investment costs and commissioning costs.
- Easy-to-use combination of controls, integrated display and symbols to show the operating status

Product information

Product information as per Regulation No. 1907/2006 (REACH)

For information as per European chemicals regulation (EC) No. 1907/2006 (REACH) see <https://www.ksb.com/en-global/company/corporate-responsibility/reach>.

Selection information

Minimum inlet pressure

The minimum inlet pressure p_{min} at the pump suction nozzle serves to avoid cavitation noises at the indicated fluid temperature T_{max} .

The indicated values are applicable up to 300 m above sea level. For installation at altitudes > 300 m, an allowance of 0.01 bar / 100 m must be added.

Table 5: Minimum inlet pressure p_{min} specified for the fluid temperature T_{max} .

Fluid temperature [°C]	Minimum inlet pressure [bar]
$\leq +70^{5)}$	0,5

Permissible fluid temperature

Table 6: Temperature limits of the fluid handled

Permissible fluid temperature	Value [°C]
Maximum	+70 ⁶⁾
Minimum	+2

Permissible ambient temperature

Table 7: Permissible ambient temperatures specified for the fluid temperature

Fluid temperature [°C]	Permissible ambient temperature [°C]
$\leq +70^{7)}$	+40

Description of the Modbus interface

Table 8: Technical data of the Modbus interface

Parameter	Description/value
Terminal cross-section	1,5 mm ²
Interface	RS485 (TIA-485-A) optically isolated
Bus connection	0.5 mm ² , shielded twisted pair bus cable
Cable length	<ul style="list-style-type: none"> ▪ 1000 m max. ▪ Stub line impermissible ▪ For cable lengths > 30 m take suitable measures to ensure overvoltage protection.
Wave impedance	120 Ω (cable type B to TIA-485-A)
Data rates [baud]	4800, 9600, 38,400, 57,600, 115,200 (19,200 = factory setting)
Protocol	Modbus RTU standard
Data format	<ul style="list-style-type: none"> ▪ 8 data bits ▪ Parity EVEN / ODD / NONE ▪ 1 stop bit
Modbus address	ID #1 to #247 selectable (ID #17 = factory setting)

Further description see operating manual of the pump set.

⁵ $\leq +75$ °C for short-time duty ≤ 5 minutes

⁶ $\leq +75$ °C for short-time duty ≤ 5 minutes

⁷ $\leq +75$ °C for short-time duty ≤ 5 minutes

Description of the Eco Mode

In Eco Mode, the pump characteristic curve (1) is quadratic. Starting at the discharge head setpoint H_s , the characteristic curve intersects the discharge head axis at $H_0 = 1/4 \times H_s$. By changing the differential pressure setpoint this pump characteristic curve can be adjusted to higher or lower differential pressures or discharge heads. Compared with the Proportional-pressure Control operating mode the Eco Mode can save more than 40 % in electrical input power. An example of a characteristic curve of a pump in Eco Mode is shown below.

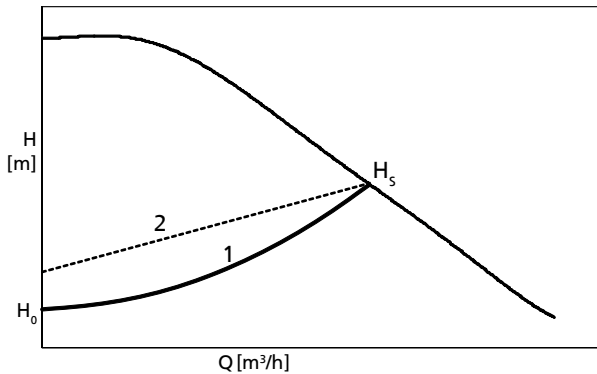

Fig. 1: Eco Mode function

1	Eco Mode characteristic curve
2	Proportional-pressure Control characteristic curve for comparison

Description of Constant-pressure Control operating mode

In Constant-pressure Control the set head ② is maintained irrespective of the flow rate. The set differential pressure setpoint H_s is constant, situated between the maximum curve ① and the permissible flow rate range.

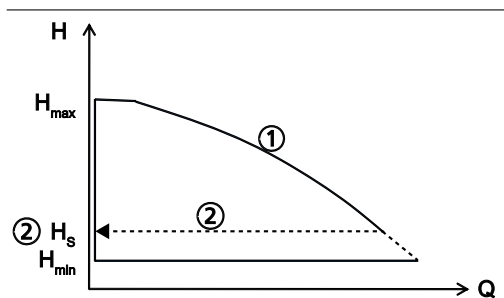

Fig. 2: Constant-pressure Control function

Dynamic Control description

The dynamic control (2) system detects when the selected control curve (3) is higher than the minimum characteristic curve⁸⁾ (4). The control system shifts the control curve downward, and power input is reduced automatically. To ensure sufficient supply the pump set switches to a higher control curve when the minimum characteristic curve is reached. The energy input is reduced (1) without any negative impact on the supply of the building. The pump set is operated in an optimised way, even if the system characteristic curve is unknown; the noise at the thermostatic valves is reduced.

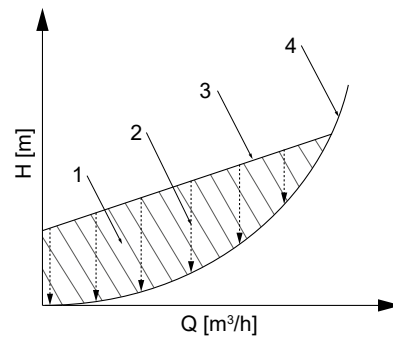

Fig. 3: Principle of dynamic control

1	Excess energy input	3	Control curve
2	Dynamic control	4	Minimum characteristic curve

Description of the characteristic curve

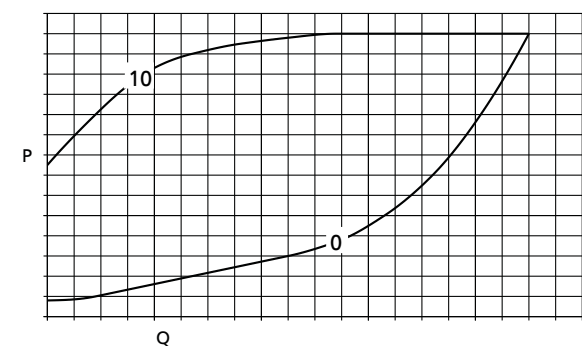
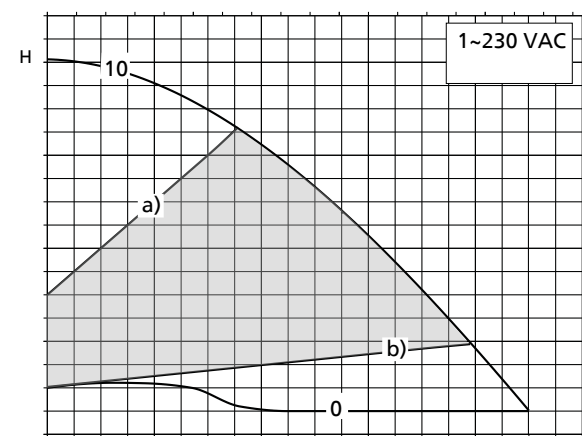

Fig. 4: Selection example

The pump characteristic curve can be adjusted between a) and b) in increments of 1 % by turning the control element.

0	Level 0 = open-loop control, minimum speed (corresponds to a setting of 0 %)
10	Level 10 = open-loop control, maximum speed (corresponds to a setting of 100 %)
■	Control range
a)	Control curve, maximum head
b)	Control curve, minimum head

⁸ Characteristic curve at fully open thermostatic valves

Technical data

CalioTherm Pro

Table 9: Technical data

Size	Connection		PN [bar]	n		P ₁ [W]	I _N 1~230 V AC, 50 Hz / 60 Hz [A]	Mat. No.	[kg]
	Piping	Pump		Min.	Max.				
				[rpm]	[rpm]				
25-80	R 1	G 1 1/2	6/10	1000	4000	3,5 - 180	0,15 - 0,86	29134853	4,6
30-100	R 1 1/4	G 2	6/10	1000	4500	3,5 - 180	0,15 - 0,85	29134854	4,8
30-120	R 1 1/4	G 2	6/10	1000	4000	3,5 - 330	0,15 - 1,50	29134855	6,4
40-80	DN 40	DN 40	6/10	1000	3600	3,5 - 265	0,15 - 1,22	29134849	11,1
40-100	DN 40	DN 40	6/10	1000	4000	3,5 - 360	0,15 - 1,65	29134856	11,1

Selection chart

CalioTherm Pro

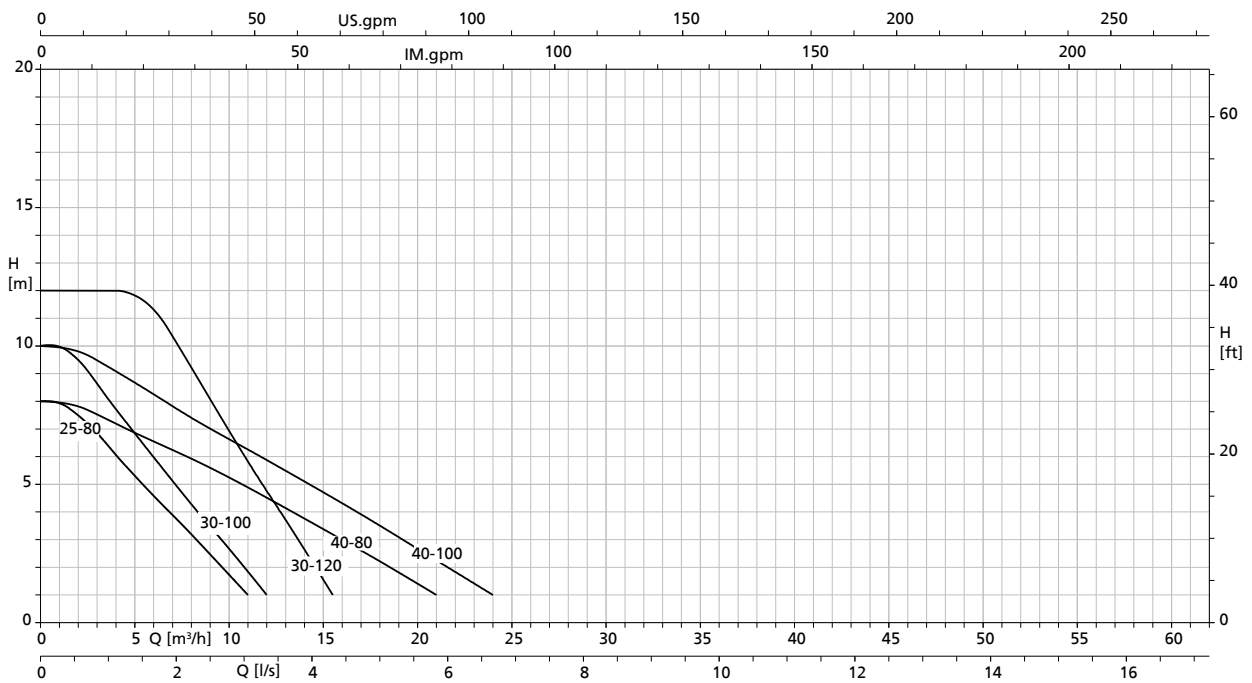

Characteristic curves

CalioTherm Pro 25-80 open-loop control, Eco Mode

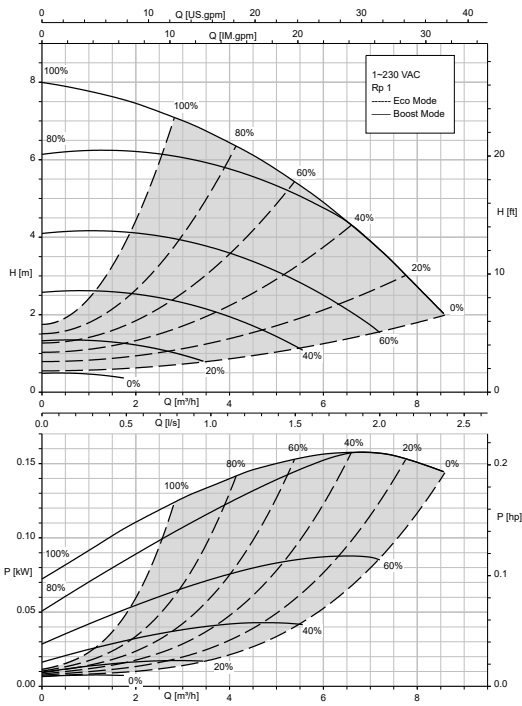

CalioTherm Pro 25-80 Δp_v , Δp_c

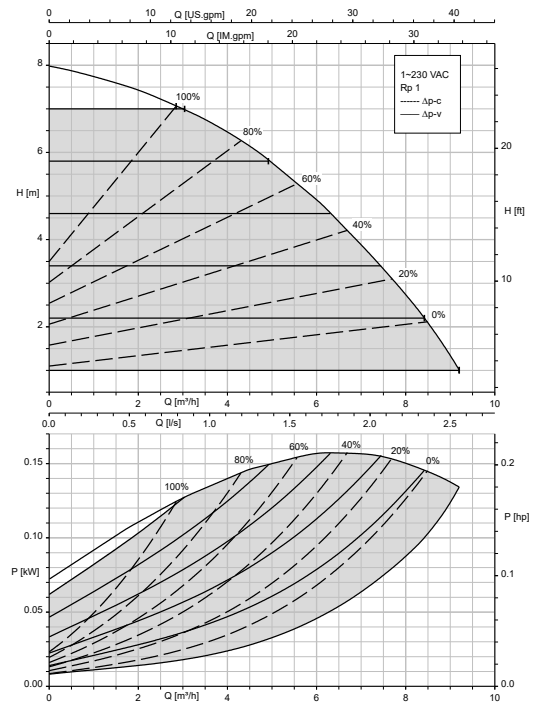

CalioTherm Pro 30-100 open-loop control, Eco Mode

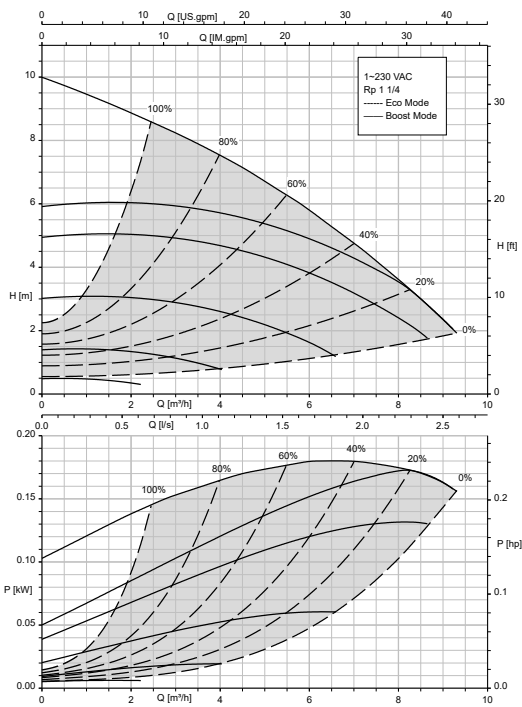

CalioTherm Pro 30-100 Δp_v , Δp_c

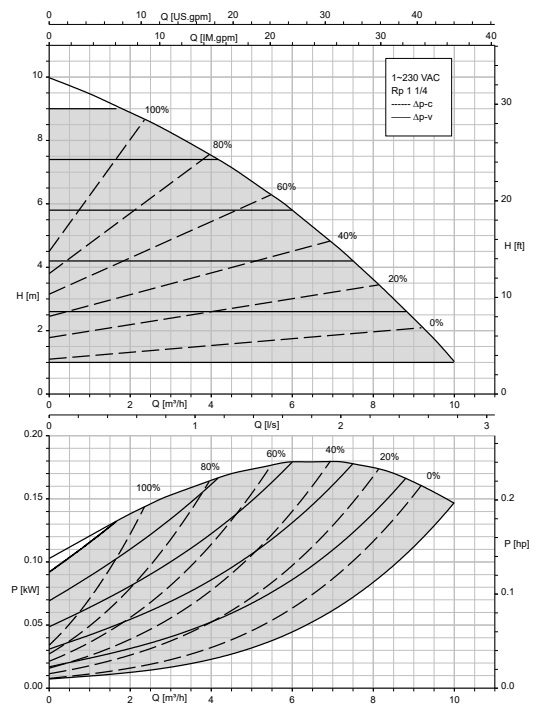

CalioTherm Pro 30-120 open-loop control, Eco Mode

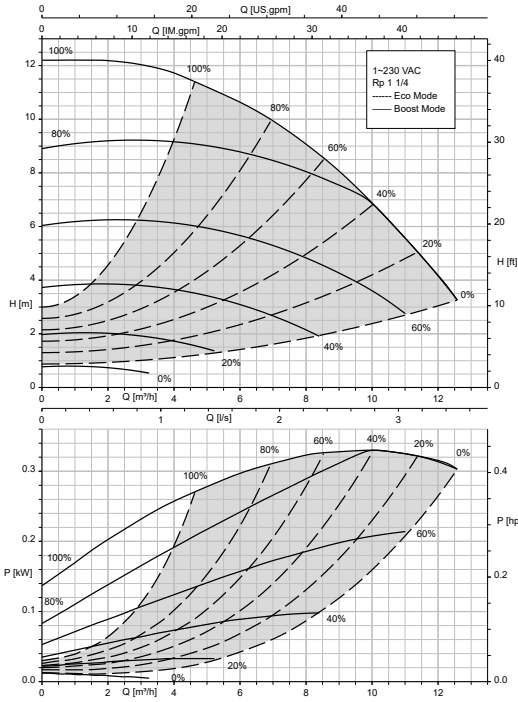

CalioTherm Pro 30-120 Δp_v , Δp_c

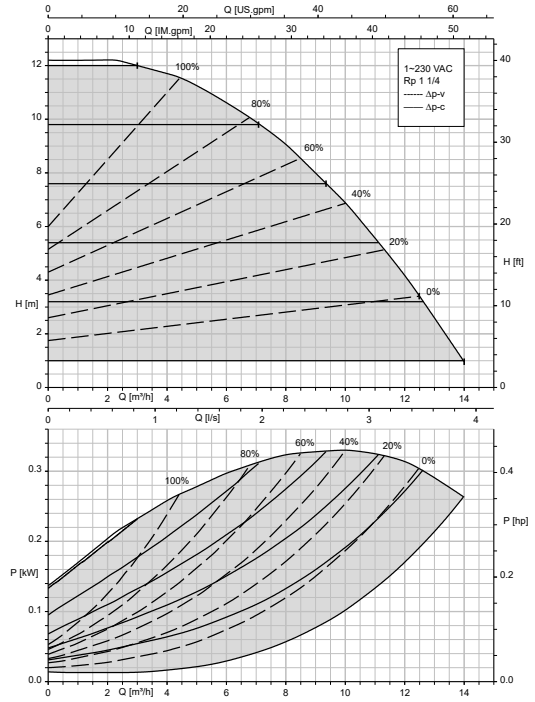

CalioTherm Pro 40-80 open-loop control, Eco Mode

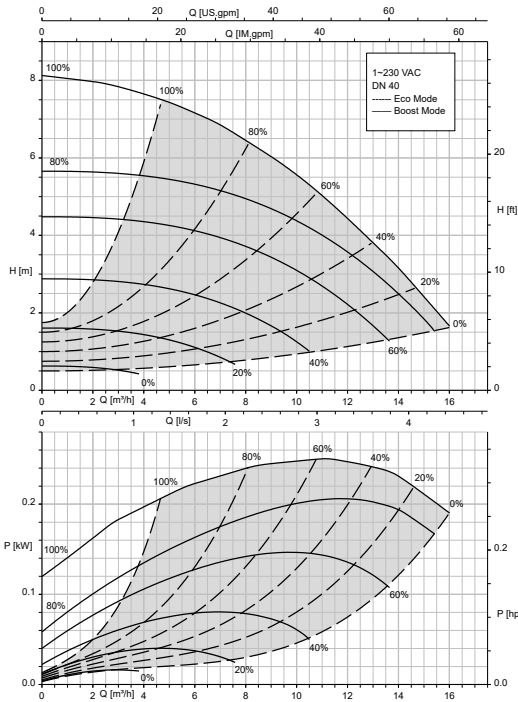

CalioTherm Pro 40-80 Δp_v , Δp_c

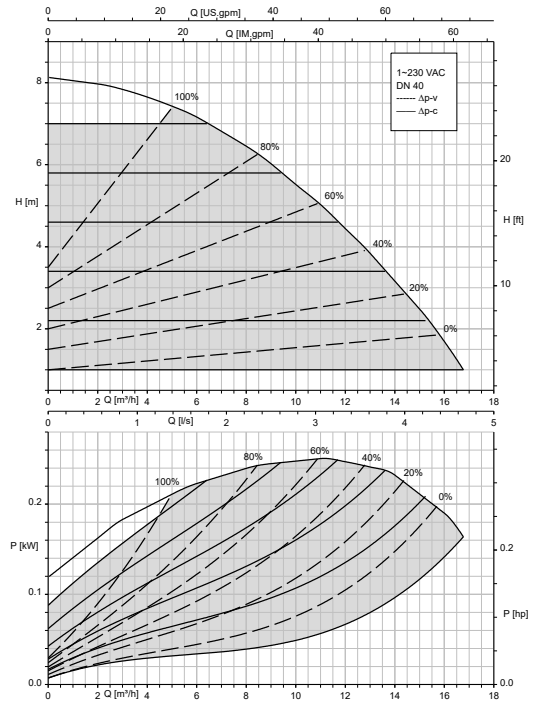

1157.581/06-EN

CalioTherm Pro 40-100 open-loop control, Eco Mode

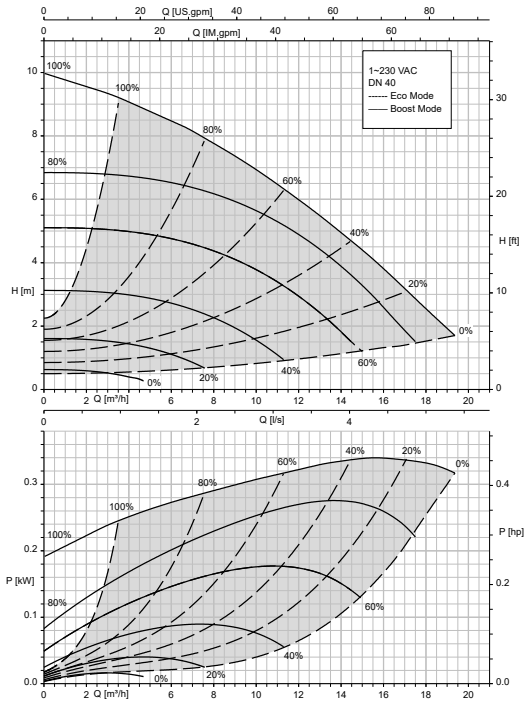

CalioTherm Pro 40-100 Δp_v , Δp_c

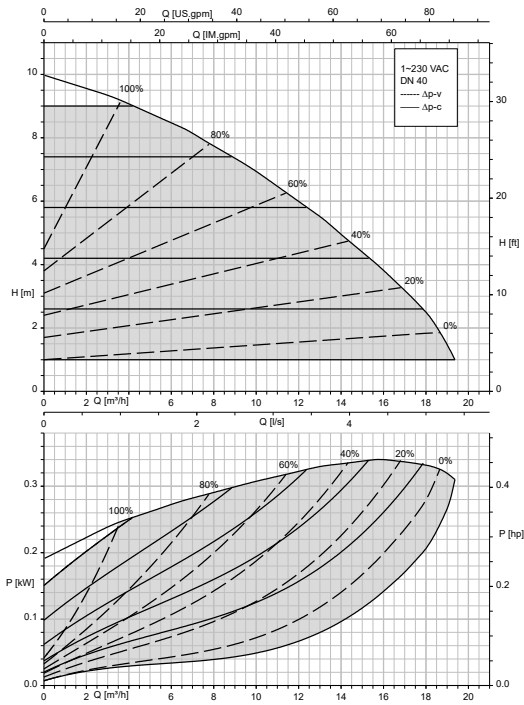

Dimensions

Pump set dimensions

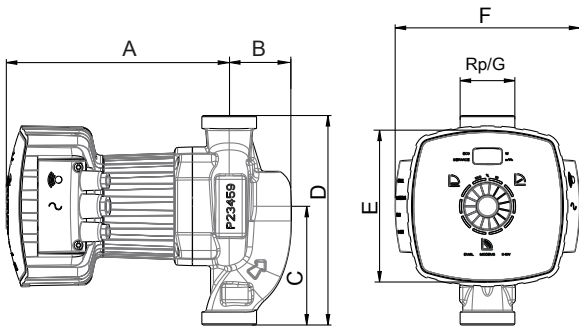

Fig. 5: Screw-ended pump set

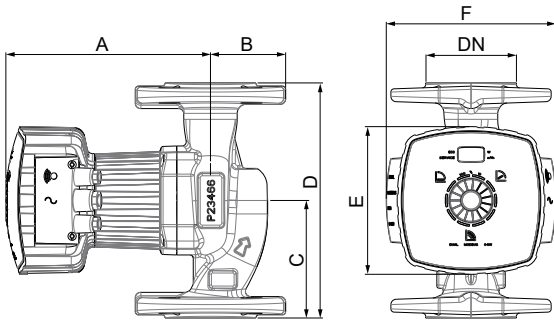

Fig. 6: Flanged pump set

Table 10: Pump set dimensions

Size	Connection			A [mm]	B [mm]	C [mm]	D [mm]	E [mm]	F [mm]
	R	G	DN						
25-80	1	1 1/2	-	197	53	98	180	137	168
30-100	1 1/4	2	-	197	53	98	180	137	168
30-120	1 1/4	2	-	232	53	98	180	137	168
40-80	-	-	40	242	70	120	220	137	168
40-100	-	-	40	242	70	120	220	137	168

Flange dimensions

Table 11: Flange dimensions

Size	PN 6			PN 10			Outline drawing
	$\varnothing D$	$\varnothing k$	$n \times \varnothing d_2$	$\varnothing D$	$\varnothing k$	$n \times \varnothing d_2$	
	[mm]	[mm]	[mm]	[mm]	[mm]	[mm]	
DN 40	130	100	4 x $\varnothing 14$	150	110	4 x $\varnothing 19$	

Installation information

Permissible installation positions

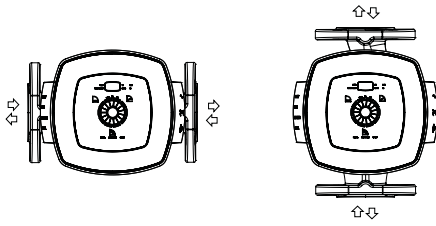

Fig. 7: Permissible installation positions

Scope of supply

Depending on the model, the following items are included in the scope of supply:

- Pump set
- Two-piece thermal insulation shell
- Gaskets
- Washers
- Installation/operating manual

Accessories



Electrical accessories

Table 12: Overview of electrical accessories

	Description	Mat. No.	[kg]
	BACnet MS/TP communication module Suitable for mounting in a control cabinet, for connecting 1 Calio / CalioTherm Pro pump	18041730	0,1

Pipe unions

Table 13: Overview of pipe unions

	Description	Mat. No.	[kg]
	2 pipe unions with G 1 1/2 union nut and insert with Rp 1 internal thread, brass For pumps with G 1 1/2 external thread / R 1 pipe connection	19075564	0,2
	2 pipe unions with G 2 union nut and insert with Rp 1 1/4 internal thread, brass for pumps with G 2 external thread / R 1 1/4 pipe connection	19075565	0,2



KSB SE & Co. KGaA
Johann-Klein-Straße 9 • 67227 Frankenthal (Germany)
Tel. +49 6233 86-0
www.ksb.com